

## Errata

**Title & Document Type:** 6516A DC Power Supply Operating and Service Manual

**Manual Part Number:** 06516-90001

**Revision Date:** October 1967

---

### HP References in this Manual

This manual may contain references to HP or Hewlett-Packard. Please note that Hewlett-Packard's former test and measurement, semiconductor products and chemical analysis businesses are now part of Agilent Technologies. We have made no changes to this manual copy. The HP XXXX referred to in this document is now the Agilent XXXX. For example, model number HP8648A is now model number Agilent 8648A.

### About this Manual

We've added this manual to the Agilent website in an effort to help you support your product. This manual provides the best information we could find. It may be incomplete or contain dated information, and the scan quality may not be ideal. If we find a better copy in the future, we will add it to the Agilent website.

### Support for Your Product

Agilent no longer sells or supports this product. You will find any other available product information on the Agilent Test & Measurement website:

[www.tm.agilent.com](http://www.tm.agilent.com)

Search for the model number of this product, and the resulting product page will guide you to any available information. Our service centers may be able to perform calibration if no repair parts are needed, but no other support from Agilent is available.

DC POWER SUPPLY

HVB SERIES, MODEL 6516A

SERIAL NUMBER PREFIX 7C

Printed: October, 1967

Ⓜ Stock Number: 06516-90001

## TABLE OF CONTENTS

Section	Page No.	Section	Page No.
I GENERAL INFORMATION.....	1-1	IV PRINCIPLES OF OPERATION (Continued)	
1-1 Description	1-1	4-24 High Voltage Control and Doubler Circuits	4-4
1-4 Overload Protection	1-1	4-28 Protection Circuit	4-5
1-7 Cooling	1-1	4-30 Reference Regulator	4-5
1-9 Output Terminals	1-1		
1-11 Specifications	1-1	V MAINTENANCE.....	5-1
1-13 Options	1-1	5-1 Introduction	5-1
1-15 Accessories	1-1	5-3 High Voltage Precautions	5-1
1-17 Instrument Identification	1-2	5-6 Measurement Techniques	5-1
1-20 Ordering Additional Manuals	1-2	5-9 Test Equipment Required	5-1
II INSTALLATION.....	2-1	5-11 Performance Test	5-4
2-1 Initial Inspection	2-1	5-14 Rated Output, Meter, and Output Controls Accuracy	5-4
2-3 Mechanical Check	2-1	5-17 Load Regulation	5-4
2-5 Electrical Check	2-1	5-19 Line Regulation	5-5
2-7 Installation Data	2-1	5-21 Ripple and Noise	5-5
2-9 Location	2-1	5-35 Transient Recovery Time	5-7
2-11 Rack Mounting	2-1	5-39 Output Impedance	5-8
2-15 Input Power Requirements	2-2	5-42 Temperature Coefficient	5-9
2-17 Power Cable	2-2	5-46 Output Stability	5-9
2-20 Repackaging for Shipment	2-2	5-49 Current Limit	5-10
III OPERATING INSTRUCTIONS.....	3-1	5-51 Troubleshooting	5-10
3-1 Turn-on Check Out Procedure	3-1	5-55 Overall Troubleshooting Procedure	5-10
3-3 Operation	3-1	5-59 Repair and Replacement	5-15
3-5 Current Limit Provisions	3-1	5-61 Adjustment and Calibration	5-17
3-7 Operation of Supply Beyond Rated Output	3-1	5-62 Meter Zero	5-17
3-9 Load Connection	3-1	5-64 Meter Accuracy Adjustment	5-17
3-13 Output Capacitance	3-2	5-66 Output Voltage (Programming Current) Adjustment	5-17
3-15 Reverse Current Loading	3-2	5-68 Output Current Limit Adjustment	5-17
3-17 Reverse Voltage Loading	3-2	5-70 Overvoltage Protection	5-17
IV PRINCIPLES OF OPERATION.....	4-1	VI REPLACEABLE PARTS.....	6-1
4-1 Overall Block Diagram	4-2	6-1 Introduction	6-1
Discussion	4-2	6-4 Ordering Information	6-1
4-8 Simplified Schematic Discussion	4-3	Reference Designators	
4-12 Detailed Circuit Analysis	4-4	Abbreviations	
4-13 Series Regulator	4-4	Manufacturers	
4-15 Constant Voltage Input Circuit	4-4	6-8 Code List of Manufacturers	6-2
4-20 Driver Amplifier	4-4	Parts List Table	6-5
4-22 Current Limit Circuit	4-4		

## TABLE OF CONTENTS (CONTINUED)

### LIST OF TABLES

Table	Page No.
1-1 Specifications.....	1-3
5-1 Test Equipment.....	5-3
5-2 Bias, Reference, and Rectifier Voltages.....	5-10
5-3 Low Output Voltage Troubleshooting.....	5-12
5-4 High Output Voltage Troubleshooting.....	5-14

### LIST OF ILLUSTRATIONS

Figure	Page No.	Figure	Page No.
1-1 DC Power Supply	iv	5-3 Line and Load Regulation, Test Setup	5-4
2-1 Rack Mounting, Two Units	2-1	5-4 Ripple and Noise, Test Setup	5-5
2-2 Rack Mounting, One Unit	2-2	5-5 High Voltage Protection Network	5-6
3-1 Front Panel Controls and Indicators	3-1	5-6 Noise Spikes, Test Setup	5-7
4-1 Overall Block Diagram	4-1	5-7 Transient Recovery Time, Test Setup	5-8
4-2 Simplified Schematic Diagram	4-3	5-8 Transient Recovery Time Waveforms	5-8
5-1 High Voltage and Troubleshooting Location Diagram	5-2	5-9 Output Impedance, Test Setup	5-8
5-2 Differential Voltmeter Substitute, Test Setup	5-4	5-10 Servicing Printed Wiring Boards	5-16

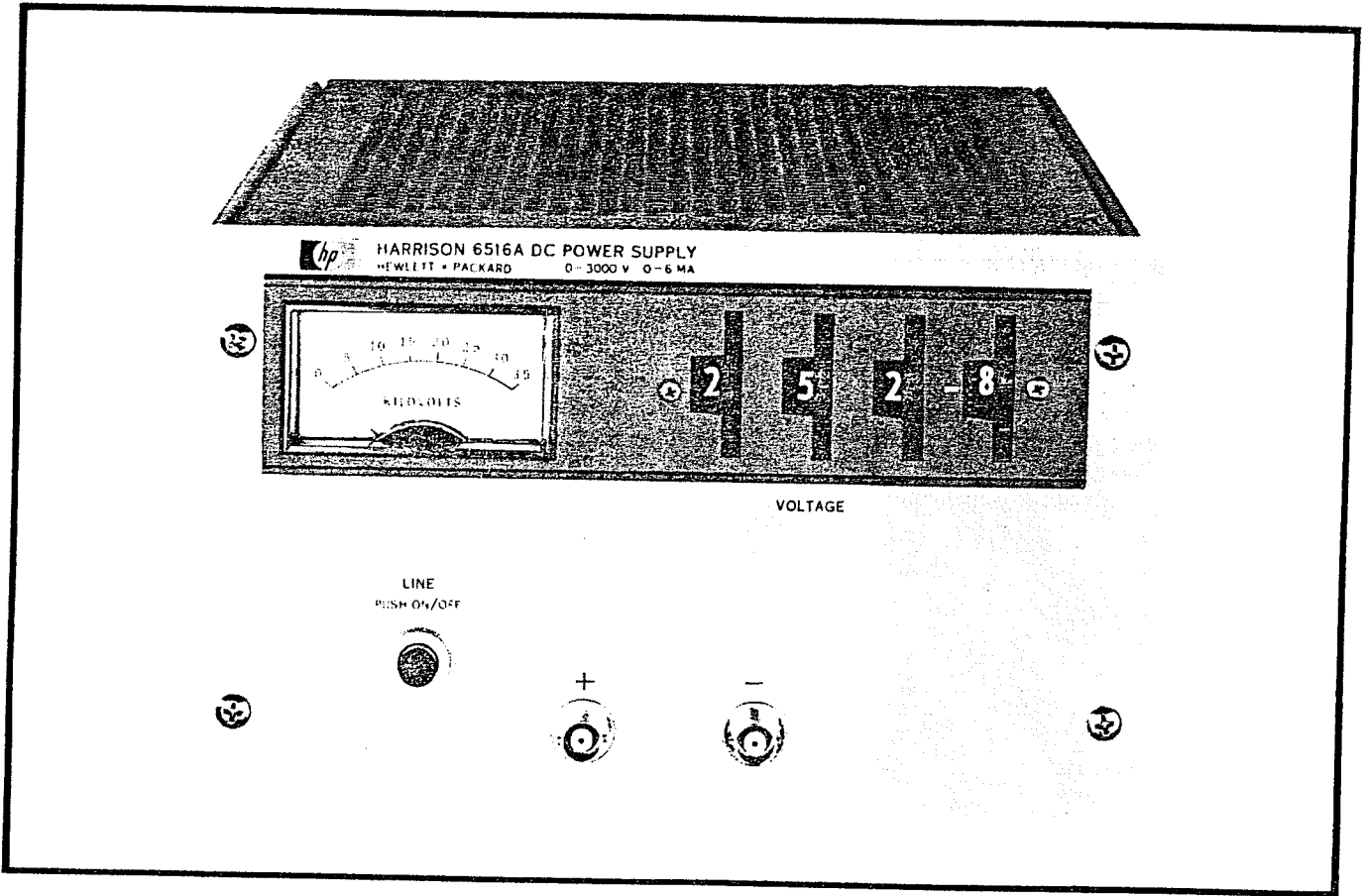

Figure 1-1. DC Power Supply, Model 6516A

SECTION I  
GENERAL INFORMATION

1-1 DESCRIPTION

1-2 This instrument (Figure 1-1) is an all semiconductor high voltage supply suitable for either bench or relay rack operation. It is a compact, well-regulated, Constant Voltage/Current Limited supply that will furnish 3,000 volts at 6 milliamps or can be adjusted throughout the output voltage range. It is designed for applications requiring extreme stability, regulation, and insensitivity to ambient temperature variations.

1-3 This supply utilizes a series regulated "piggy-back" circuit technique that consists of placing a well-regulated low voltage power supply in series with a less well-regulated supply having a greater voltage capability. The well-regulated "piggy-back" supply continuously compensates for any ripple, load regulation, or line regulation deficiencies of the main power source and adjusts the voltage across its series regulator so that the total output voltage remains constant despite disturbances in the main voltage source.

1-4 OVERLOAD PROTECTION

1-5 The voltage thumbwheel switches select the constant voltage level; an internal potentiometer selects the current limit level. The supply will automatically crossover from constant voltage to current limit operation and vice versa if the output current or voltage exceeds these preset levels. Detailed characteristics of the output current limiting are given in Paragraph 3-5.

1-6 The power supply is protected from reverse voltage (positive voltage applied to negative terminal) by an internal protection diode that shunts current across the output terminals when this condition exists, clamping the reverse voltage. Protection from reverse current (current forced into the power supply in the direction opposite to the output current) must be provided by preloading the power supply (Paragraph 3-15). The power supply cannot accept reverse current without damage.

1-7 COOLING

1-8 Convection cooling is used; no fan is required. The power supply has no moving parts except for the meter movement.

1-9 OUTPUT TERMINALS

1-10 Output power is available via two UG-931/U connectors mounted on the front panel of the supply. Mating connectors (UG-932/U) are supplied with the unit. The output terminals are isolated from the chassis and either the positive or the negative terminal may be connected to the chassis by shorting the center pin to the case of the applicable UG-931/U connector, or by grounding a wire from the connector to the chassis. The power supply is insulated to permit operation up to 1,000 volts dc off ground, i.e. the maximum potential between either output terminal and ground shall not exceed 4KVdc.

1-11 SPECIFICATIONS

1-12 Detailed specifications for the power supply are given in Table 1-1.

1-13 OPTIONS

1-14 Options are factory modifications of a standard instrument that are requested by the customer. The following options are available for the instrument covered by this manual. Where necessary, detailed option information (operation, alignment, etc.) is included throughout the manual.

Option No.    Description

05	<u>50Hz Input Modification.</u> Factory modification includes the substitution of 60Hz with 50Hz magnetic component as indicated at the end of the parts list in Section VI. In addition, the overvoltage protection adjustment is rechecked, refer to Section V.
18	<u>230Vac ±10%, Single-Phase Input.</u> Factory modification includes the installation of a 230 volt input transformer to replace the standard 115 volt transformers as indicated at the rear of the parts list in Section VI.

1-15 ACCESSORIES

1-16 The accessories listed in the following chart may be ordered with the power supply or separately

from your local  sales office. (Refer to list at rear of manual for addresses.) Additional information on accessories is given in Section II.

 Part No.	Description
14515A	Rack Kit for Mounting one 5 $\frac{1}{4}$ " H supply in a standard 19" EIA rack. (Refer to Section II for details.)
14525A	Rack Kit for mounting two 5 $\frac{1}{4}$ " H supplies in a standard 19" EIA rack. (Refer to Section II for details.)

#### 1-17 INSTRUMENT IDENTIFICATION

1-18 Hewlett-Packard power supplies are identified by a three-part serial number tag. The first part is the power supply model number. The second part is the serial number prefix, which consists of a number-letter combination that denotes the date of a significant design change. The number

designates the year, and the letter A through L designates the month, January through December, respectively. The third part is the power supply serial number; a different sequential number is assigned to each power supply.

1-19 If the serial number prefix on your power supply does not agree with the prefix on the title page of this manual, use the change page that is included to update the manual to the proper serial number. Where applicable, backdating information is given in an appendix at the rear of the manual.

#### 1-20 ORDERING ADDITIONAL MANUALS



1-21 One manual is shipped with each power supply. Additional manuals may be purchased from your local  sales office (see list at rear of this manual for addresses). Specify the model number, serial number prefix, and  stock number provided on the title page.

Table 1-1. Specifications

**OUTPUT:**

0-3000Vdc, 0-6 milliamperes.

**INPUT:**

115Vac  $\pm$ 10%, single phase, 57-63Hz, 1A, 40W.

**LOAD REGULATION:**

Less than 0.01% or 16mV (whichever is greater) output voltage change for a full load to no load change in output current.

**LINE REGULATION:**

Less than 0.01% or 16mV (whichever is greater) output voltage change for a 10% change in the nominal line voltage.

**RIPPLE AND NOISE:**

Less than 2mVrms, 5mV p-p.

**TEMPERATURE RANGES:**

Operating: 0 to 55°C. Storage: -20 to +85°C.

**TEMPERATURE COEFFICIENT:**

Less than 0.02% +2mV output voltage change per °C after 30 minute warm-up.

**STABILITY:**

Less than 0.05% +5mV total drift for 8 hours after 30 minute warm-up and with 3°C ambient variation.

**OUTPUT IMPEDANCE:**

Less than 32 ohms from dc to 30Hz.  
Less than 8 ohms from 30Hz to 100kHz.  
Less than 2 ohms from 100kHz to 1MHz.

**TRANSIENT RECOVERY TIME:**

Less than 100 $\mu$  seconds is required for output voltage to recover to within 0.01% or 16mV of the nominal output voltage following a full load change in output current. The nominal output

voltage is defined as the mean between the no load and full load voltage.

**OVERLOAD PROTECTION:**

An all electronic, continuously acting current limit protects the power supply for all overloads regardless of how long imposed, including a direct short circuit across the output terminals.

**CONTROLS:**

An in-line 4-digit (thumbwheel) voltage programmer permits control of the output voltage; resolution is 1V.

**METER:**

The front panel meter is a 0-3500V voltmeter.

**OUTPUT TERMINALS:**

The dc output of the supply is floating; thus, the supply can be used as either a positive or negative source. Terminals for +OUT, -OUT, and GND are provided on the front of the supply.

**COOLING:**

Convection cooling is employed. The supply has no moving parts.

**SIZE:**

8 $\frac{1}{2}$ " W x 5 $\frac{1}{4}$ " H x 16" D. Two of the units can be mounted side by side in a standard 19" relay rack.

**WEIGHT:**

17 lbs. net, 20 lbs. shipping.

**FINISH:**

Light gray front panel with dark gray case.

**POWER CORD:**

A 3-wire 5-foot power cord is provided with each unit.



## SECTION II INSTALLATION

### 2-1 INITIAL INSPECTION

2-2 Before shipment, this instrument was inspected and found to be free of mechanical and electrical defects. As soon as the instrument is unpacked, inspect for any damage that may have occurred in transit. Save all packing materials until the inspection is completed. If damage is found, proceed as described in the Claim for Damage in Shipment section of the warranty page at the rear of this manual.

### 2-3 MECHANICAL CHECK

2-4 This check should confirm that there are no broken knobs or connectors, that the cabinet and panel surfaces are free of dents and scratches, and that the meter is not scratched or cracked.

### 2-5 ELECTRICAL CHECK

2-6 The instrument should be checked against its electrical specifications. Section V includes an "in-cabinet" performance check to verify proper instrument operation.

### 2-7 INSTALLATION DATA

2-8 The instrument is shipped ready for bench operation. It is necessary only to connect the instrument to a source of power and it is ready for operation.

### 2-9 LOCATION

2-10 This instrument is air cooled. Sufficient space should be allotted so that a free flow of cooling air can reach the sides and rear of the instrument when it is in operation. It should be used in an area where the ambient temperature does not exceed 55°C.

### 2-11 RACK MOUNTING

2-12 This instrument may be rack mounted in a standard 19 inch rack panel either alongside a similar unit or by itself. Figures 2-1 and 2-2 show how both types of installations are accomplished.

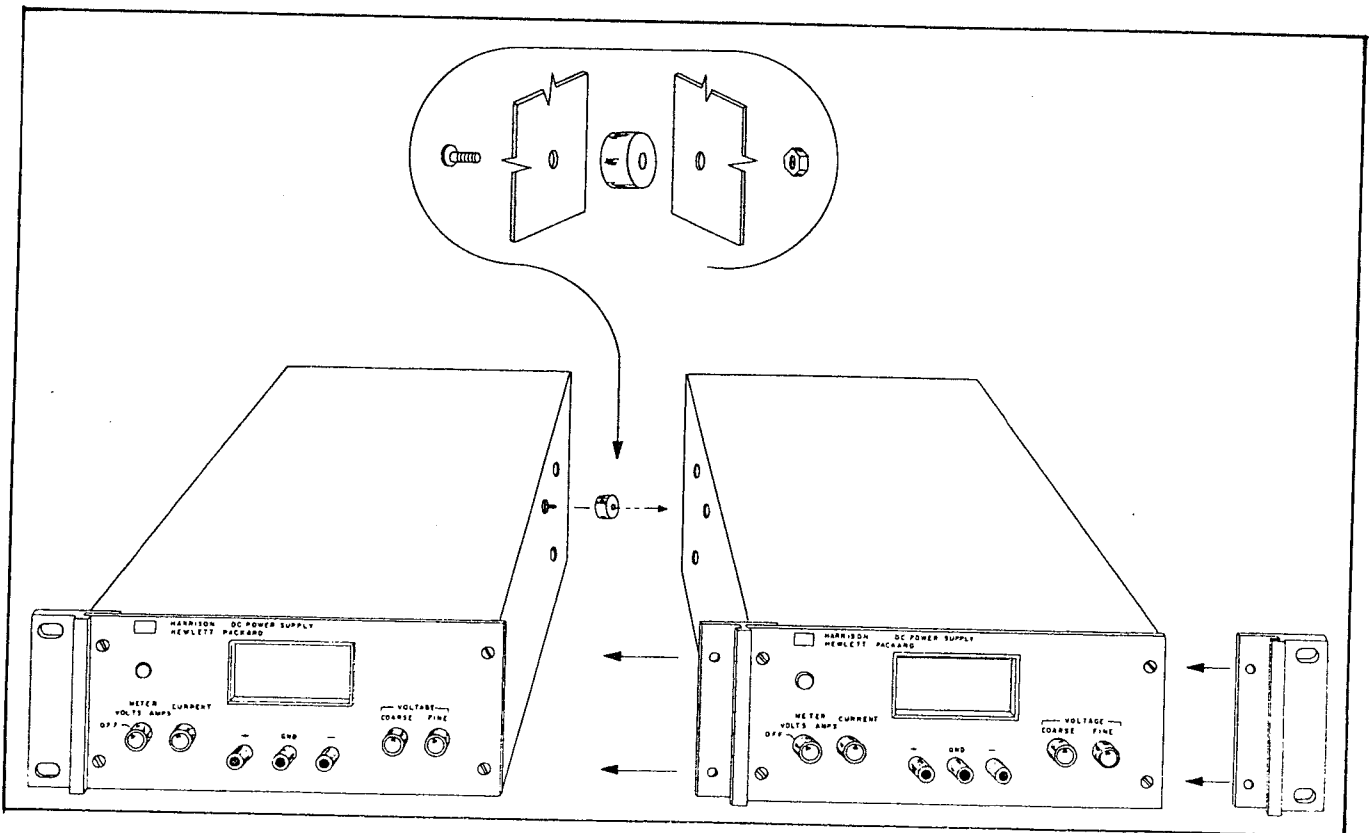

Figure 2-1. Rack Mounting, Two Units

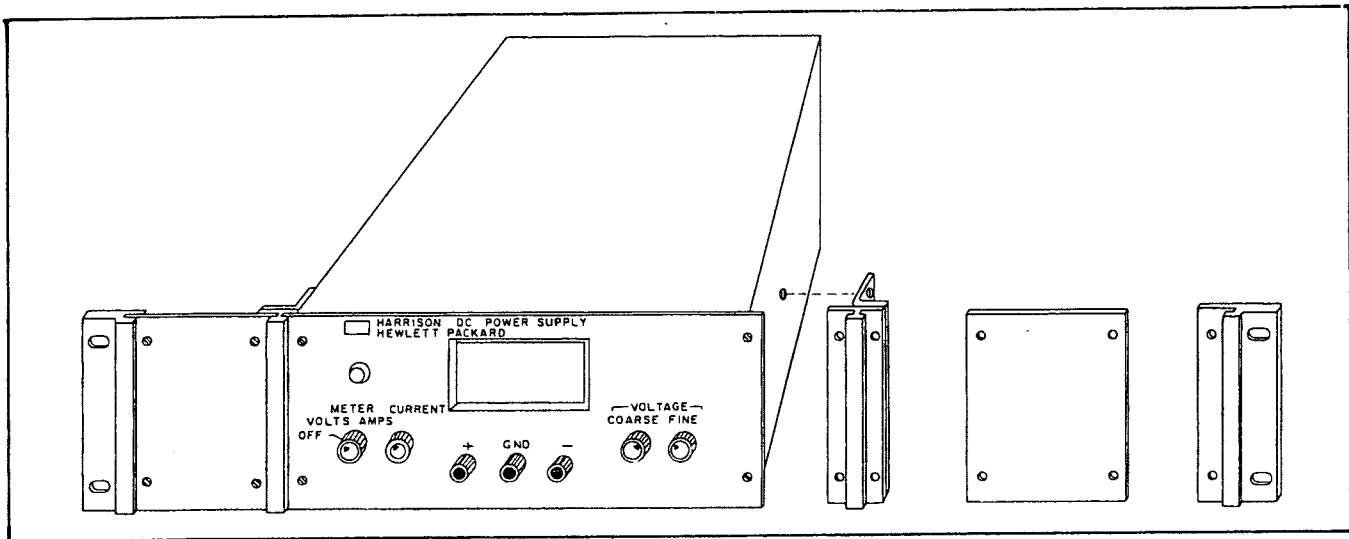

Figure 2-2. Rack Mounting, One Unit

2-13 To mount two units side-by-side, proceed as follows:

- a. Remove the four screws from the front panels of both units.
- b. Slide rack mounting ears between the front panel and case of each unit.
- c. Slide combining strip between the front panels and cases of the two units.
- d. After fastening rear portions of units together using the bolt, nut, and spacer, replace panel screws.

2-14 To mount a single unit in the rack panel, proceed as follows:

- a. Bolt rack mounting ears, combining strips, and angle brackets to each side of center spacing panels. Angle brackets are placed behind combining strips as shown in Figure 2-2.
- b. Remove four screws from front panel of unit.
- c. Slide combining strips between front panel and case of unit.
- d. Bolt angle brackets to front sides of case and replace front panel screws.

#### 2-15 INPUT POWER REQUIREMENTS

2-16 This power supply is operated from a nominal 115 volt 60 Hz power source. The input power required when operated from a 115 volt 60 Hz power source at full load is:

Model 6110A	60 Watts
Model 6516A	40 Watts

#### 2-17 POWER CABLE

2-18 To protect operating personnel, the National Electrical Manufacturers Association (NEMA) recommends that the instrument panel and cabinet be grounded. This instrument is equipped with a three conductor power cable. The third conductor is the ground conductor and when the cable is plugged into an appropriate receptacle, the instrument is grounded. The offset pin on the power cable three-prong connector is the ground connection.

2-19 To preserve the protection feature when operating the instrument from a two-contact outlet, use a three-prong to two-prong adapter and connect the green lead on the adapter to ground.

#### 2-20 REPACKAGING FOR SHIPMENT

2-21 To insure safe shipment of the instrument, it is recommended that the package designed for the instrument be used. The original packaging material is reusable. If it is not available, contact your local Hewlett-Packard field office to obtain the materials. This office will also furnish the address of the nearest service office to which the instrument can be shipped. Be sure to attach a tag to the instrument which specifies the owner, model number, full serial number, and service required, or a brief description of the trouble.

## SECTION III OPERATING INSTRUCTIONS

### 3-1 TURN-ON CHECK OUT PROCEDURE

3-2 The following procedure describes the use of the front panel controls and indicators illustrated in Figure 3-1 and insures that the power supply is operational.

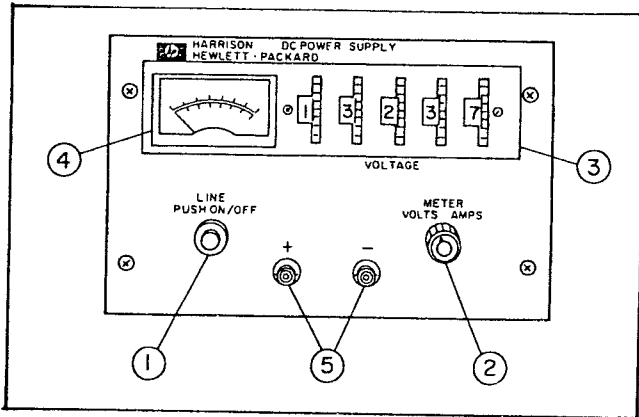

Figure 3-1. Front Panel Controls and Indicators

- a. Push ON/OFF switch-indicator (1); indicator should light.
- b. Set METER switch (2) to VOLTS position (6110A only).
- c. Adjust voltage thumbwheel switches for desired output voltage as indicated on meter.
- d. Attach a multimeter to the output and set the voltage decadal control to at least 200 volts. Check that the current indication on the multimeter does not exceed 7.5mA.
- e. Remove meter and connect load to output terminals.

### 3-3 OPERATION

3-4 The power supply can be operated as a single unit (normal operation) or in parallel. No provisions for remote programming or remote sensing have been made due to their limited use and insulation problems at 3,000Vdc. For safety, insure that the power supply chassis is grounded (either via power cord or by other means). The operator can ground either output terminal or operate the power supply up to 1,000 volts dc off ground (floating). It is not recommended that the power supply be floated above 300 volts rms at low audio frequencies (less than 500Hz).

### WARNING

Serious injury to personnel can occur if the power supply chassis is ungrounded. The warranty is void if the chassis is ungrounded during operation.

### NOTE

This supply emits a ticking sound which is characteristic of normal operation. It in no way indicates that the power supply is malfunctioning.

### 3-5 CURRENT LIMIT PROVISIONS

3-6 The current limiting feature is designed to protect the power supply and the load. It is factory adjusted by selecting resistor R20 so that the short-circuit output current will not exceed approximately 8mA.

### 3-7 OPERATION OF SUPPLY BEYOND RATED OUTPUT

3-8 The shaded area on the front panel meter face indicates the amount of output voltage that is available in excess of the normal rated output. Although the supply can be operated in this shaded region without being damaged, it cannot be guaranteed to meet all its performance specifications. However, if the line voltage is maintained above 115Vac, the power supply will probably operate within its specifications.

### 3-9 LOAD CONNECTION

3-10 Output terminals are provided on the front panel of the power supply; mating connectors are UG-932 and cable type is RG-59/U. The positive or negative output terminal may be grounded by shorting the center pin and case of the applicable UG-931/U jack; or both output terminals ungrounded (floating operation). Floating operation is permitted to 1,000 volts dc off ground; neither output terminal should exceed 4,000 volts dc. The best ripple-free results are obtained when one output jack is grounded and the load is connected to the other output jack by the appropriate cable and connector.

### WARNING

To avoid injury to personnel due to arcing, turn off the power supply before connecting or disconnecting the load connectors.

3-11 Each load should be connected to the power supply output terminals using separate pairs of connecting wires. This will minimize mutual coupling effects between loads and will retain full advantage of the low output impedance of the power supply. Each pair of connecting wires should be as short as possible to reduce noise pickup. In addition, a 0.1 to 1.0 $\mu$ f capacitor should be connected between one terminal and the chassis, if the supply is floated off of ground.

3-12 If load considerations require that the output power distribution terminals be remotely located from the power supply, then the power supply output terminals should be connected to the remote distribution terminals via a pair of shielded wires and each load connected separately to the remote distribution terminals. A 0.1 to 1.0 $\mu$ f capacitor should be connected across the remote distribution terminals to reduce high frequency coupling and noise.

### 3-13 OUTPUT CAPACITANCE

3-14 An internal capacitor, across the output terminals of the power supply, helps to supply high current pulses of short duration during constant voltage operation. Any capacitance added externally will improve the pulse current capability, but will decrease the safety provided by the cur-

rent limiting circuit. A high current pulse may damage load components before the average output current is large enough to cause the current limiting circuit to operate.

### 3-15 REVERSE CURRENT LOADING

3-16 Active loads connected to the power supply may actually deliver a reverse current to the power supply during a portion of its operating cycle. An external source cannot be allowed to pump current into the supply without loss of regulation and possible damage to the output capacitor. To avoid these effects, it is necessary to preload the supply with a "dummy" load so that the power supply delivers current through the entire operating cycle of the load device.

### 3-17 REVERSE VOLTAGE LOADING

3-18 A diode is connected across the output terminals. Under normal operating conditions, the diode is reverse biased (anode connected to negative terminal). If a reverse voltage is applied to the output terminals (positive voltage applied to negative terminal), the diode will conduct, shunting current across the output terminals and limiting voltage to the forward voltage drop of the diode. This diode protects the series transistors and the output electrolytic capacitors.

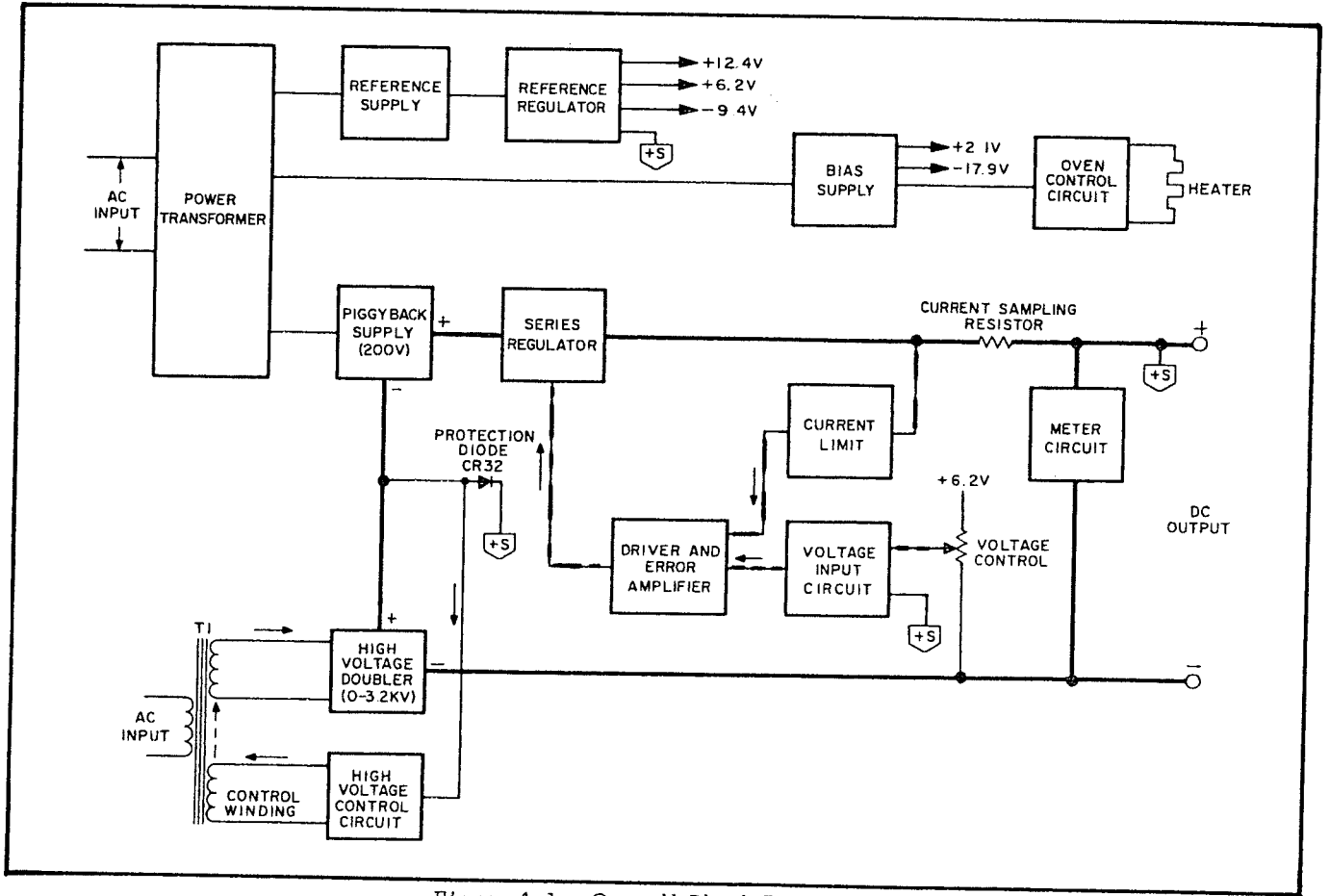

Figure 4-1. Overall Block Diagram

SECTION IV  
PRINCIPLES OF OPERATION

4-1 OVERALL BLOCK DIAGRAM DISCUSSION  
(Figure 4-1)

4-2 Models 6110A and 6516A, as illustrated in Figure 4-1, are constant voltage/current limited power supplies that utilize a "piggy-back" regulator design. This design extends the usefulness of the series regulating transistors rated for approximately 30 volts to short-circuit-proof power supplies rated for 3,000 volts. The basic technique consists of placing the well-regulated low-voltage "piggy-back" supply in series with a less well-regulated high voltage doubler. Notice, however, that the amplified error signal from the voltage input circuit is dependant upon the total output voltage—not just the output of the "piggy-back" supply alone. Thus, the well-regulated "piggy-back" supply continuously compensates for any ripple, load regulation, or line regulation deficiencies of the high voltage doubler, and adjusts the voltage across the series regulator so that the total output voltage remains constant despite disturbances in the high voltage doubler.

4-3 For purposes of discussion the voltage values of Model 6110A are used in the following paragraphs, however, the theory pertains equally well to both Models 6110A and 6516A. The "piggy-back" supply develops 200 volts, and the high voltage doubler supply is capable of providing a maximum of 3200 volts. With 30 volts normally dropped across the series regulator, the maximum output of this supply is 3370 volts; 170 volts from the "piggy-back" supply and 3200 volts from the high voltage doubler. Thus, the series regulator of the "piggy-back" supply has a voltage range for accomplishing the dynamic changes necessary to compensate for the variations of the power source. Short-circuit protection for the series regulator in the "piggy-back" supply is provided by the protection diode, which provides a discharge path from the positive side of the power supply to the positive side of the high voltage doubler shunting the short circuit current around the series regulator. Whenever the load resistance decreases to a value such that +S becomes greater than -200 volts, the protection diode conducts. This prevents the output terminals of the "piggy-back" supply from ever reversing polarity, and the series regulator will never be called upon to withstand a voltage strain greater than 200 volts from its own rectifier.

4-4 The ac input line voltage is raised to the proper level and coupled to the "piggy-back" sup-

ply. This supply converts the ac input to raw dc which is fed to the positive terminal via the series regulator and current sampling resistor network. The regulator, part of the feedback loop, is made to alter its conduction to maintain a constant output voltage or limit the output current. Voltage developed across the current sampling resistor is the input to the current limiting circuit. If the output current that passes through the sampling network exceeds a certain predetermined level, the current limiting circuit applies a feedback signal to the series regulator which alters the regulator's conduction so that the output current does not exceed the predetermined limit.

4-5 The voltage input circuit obtains its input by sampling the output voltage of the supply at the voltage control. Any changes in output voltage are detected in the constant voltage input circuit, amplified by the error amplifier and driver, and applied to the series regulator in the correct phase and amplitude to counteract the change in output voltage. The reference regulator circuit provides stable reference voltages which are used by the constant voltage input circuit and the current limiting circuit for comparison purposes.

4-6 The high voltage control circuit monitors the voltage across the "piggy-back" supply, and alters the conduction of transformer T1 so that the output of the high voltage doubler can be varied between 0 and 3.2 kilovolts. For instance, if the high voltage control is adjusted for an output voltage in excess of the voltage supplied by the "piggy-back" supply, the input to the high voltage control circuit becomes more negative. The high voltage control circuit opens the control winding, and all the energy appearing at the ac input of transformer T1 is coupled to the secondary which is connected to the high voltage doubler. The result is that the output voltage of the high voltage doubler increases. If the voltage control is adjusted for an output which is less than the "piggy-back" supply, the input to the high voltage control circuit becomes less negative. The control winding of transformer T1 becomes shorted impeding the transfer of energy from the ac input to the secondary which is connected to the high voltage doubler. Thus, the output voltage of the high voltage doubler decreases.

4-7 In Model 6110A, an oven houses the temperature sensitive components in the supply to provide a low temperature coefficient which results in excellent stability. The oven control circuit maintains the oven temperature at 65°C.

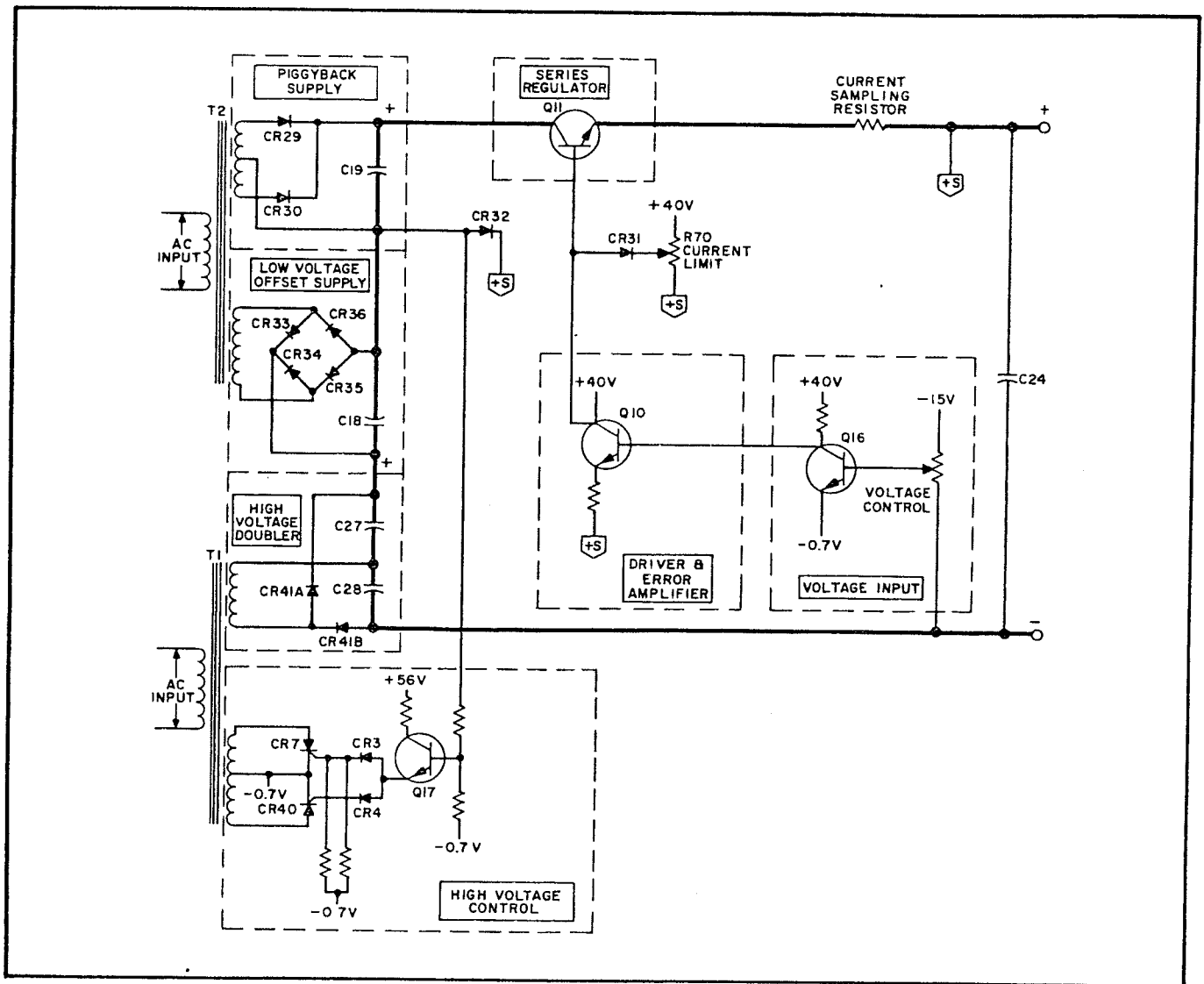

Figure 4-2. Simplified Schematic Diagram

4-8 SIMPLIFIED SCHEMATIC DISCUSSION  
(Figure 4-2)

4-9 The regulating feedback loop, consisting of the thumbwheel switch assembly (programming resistors), voltage input circuit, driver and error amplifier, series regulator, and high voltage control circuit, function continuously to maintain the output voltage constant during constant voltage operation and the output current at a safe limit during current limit operation.

4-10 The voltage input circuit amplifier, Q16 detects an error voltage that is proportional to the difference between the voltage across its programming resistors (thumbwheel switch assembly) and the dc output voltage. The error signal is ampli-

fied by Q10 and applied to the series regulator. The series regulator increases or decreases the output current as required to maintain a constant dc output voltage that is equal to the programmed voltage. The high voltage control circuit, transformer T1, and the high voltage doubler maintain the voltage across the series regulator within a limited range. When the voltage across the series regulator falls below a predetermined level, Q17 turns on, forward biasing diodes CR3 and CR4. SCR's CR7 and CR40 begin firing on each cycle, and the voltage across C27 and C28 decays. When the voltage across the series regulator rises above a predetermined level, Q17 turns off, reverse biasing diodes CR3 and CR4. SCR's CR7 and CR40 stop firing and the voltage across C27 and C28 rises.

4-11 The current limit circuit protects the load and the series regulator against excessive currents. If the external load resistance is decreased to a point where the load current exceeds the value selected by resistor R70, the positive voltage on the collector of Q10 forward biases CR31. Thus, the collector of Q10 is clamped and the output current is maintained at a constant safe maximum. Any further decreases in load resistance cause the output voltage to decrease proportionally.

4-12 DETAILED CIRCUIT ANALYSIS (Refer to overall schematic at rear of manual)

#### 4-13 SERIES REGULATOR

4-14 The series regulator consists of transistor stage Q11. The regulator serves as a series control element by altering its conduction so that the output voltage and current limit is never exceeded. The conduction of Q11 is controlled by the feedback voltage obtained from driver Q10.

#### 4-15 CONSTANT VOLTAGE INPUT CIRCUIT

4-16 This circuit consists of voltage decade control R200 through R224 and amplifier Q16.

4-17 The constant voltage input circuit continuously compares a fixed reference voltage with a portion of the output voltage and, if a difference exists, produces an error voltage whose amplitude and phase is proportional to the difference. The error output is fed back to the series regulator, through the error and driver amplifiers. The error voltage changes the conduction of the series regulator which, in turn, alters the output voltage so that the difference between the two input voltages applied to the differential amplifier is reduced to zero. The above action maintains the output voltage constant.

4-18 The base of Q16 is connected to the junction of the programming resistors and the current pull-out resistor, R18, through a current limiting resistor R19. Diode CR5 limits voltage excursions on the base of Q16. R19 limits the current through the programming resistors under the condition of rapid voltage turn-down. Capacitors C4 shunts the programming resistors to increase the high frequency gain of the amplifier. The programming current is determined primarily by the reference voltage and the pull-out resistor, R18.

4-19 Negative feedback is coupled from the output to the input of Q16 by network R20 and C20. This feedback provides high frequency roll-off in the loop gain to stabilize the feedback loop.

#### 4-20 DRIVER AMPLIFIER

4-21 The driver amplifier circuit raises the level of the error signal from the constant voltage input circuit to a sufficient level to drive the series regulator.

#### 4-22 CURRENT LIMIT CIRCUIT

4-23 The output current flows through R23 producing a voltage drop of 1.8 volts for 7 milliamps output current. The positive voltage appearing on R23 is connected to the emitter of Q10. When the output current reaches 7 milliamps diode CR8 is forward biased and the base of Q10 is clamped so that the conduction of Q10 is limited. The value of resistor R70 determines the level at which the output current will be limited. This value is normally selected for 7 milliamps output current.

#### 4-24 HIGH VOLTAGE CONTROL AND DOUBLER CIRCUITS

4-25 This circuit controls the voltage output of the high voltage doubler as a function of the voltage across the series regulator and resistor R54. When the voltage across the series regulator rises to a predetermined value, CR39 becomes forward biased and Q17 conducts. Diodes CR3 and CR4 are forward biased and on alternate half-cycles SCR's CR7 and CR40 fire, shorting the control winding of transformer T1. This action decreases the voltage on the secondary of T1 thus reducing the charge on capacitors C27 and C28. This, in turn, reduces the voltage drop across the series regulator.

4-26 When the voltage drop across the series regulator decreases to a predetermined amount, diode CR39 becomes reverse biased and Q17 turns off. This action reverse biases diodes CR3 and CR4 and the SCR's cease firing on alternate half-cycles. The output of the high voltage doubler rises until Q17 again begins to conduct.

4-27 Diodes CR3 and CR4 form an OR-gate that prevents the interaction of SCR's CR7 and CR40. For example, when CR7 fires a positive pulse appears on its gate, back biasing CR3 and preventing this positive pulse from tripping CR40. Two RFI filters in the control winding of transformer T1 prevent spikes from being transferred to the high voltage doubler and the ac input line. These filters consist of C29, R61, C26, R74 and L2. Diode CR39 protects the base of transistor Q7 from the negative output voltage of the "piggy-back" supply. This voltage can go as far negative as -215 volts.



#### 4-28 PROTECTION CIRCUIT

4-29 This circuit prevents the high voltage doubler from exceeding approximately 4kV which might occur if the feedback loop were to malfunction. Diodes CR37 and CR38 are connected directly across the control winding and rectify (monitor) the voltage across this winding. The rectified voltage charges capacitor C24, and when it exceeds a predetermined level, neon tube VR3 fires. The resulting positive going voltage turns on Q17 which in turn shorts the control winding of transformer T1, thus, reducing the output of the high voltage doubler. Overvoltage control R71 determines the level at which VR3 will fire and, therefore, controls the maximum output voltage of the high voltage doubler.

#### 4-30 REFERENCE REGULATOR

4-31 This circuit supplies regulated dc bias voltages to the voltage input circuit and +15V programming voltage to the voltage control circuit. Diodes CR22 through CR25 and capacitor C16 rectify and filter the 43 Vac developed across the secondary of T2. The 56 Vdc is regulated by transistor Q12 which is controlled by Q13 and VR1. The +15V programming voltage is developed by constant current amplifier Q14-Q15 which is connected to the -40V reference voltage. Resistors R51 and R52 are selected to provide precisely the correct programming current. Procedures for selecting these resistors are included in the adjustment and calibration paragraphs in Section V, Maintenance.

## SECTION V MAINTENANCE

### 5-1 INTRODUCTION

5-2 Upon receipt of the power supply, the performance check (Paragraph 5-11) should be made. This check is suitable for incoming inspection. If a fault is detected in the power supply while making the performance check or during normal operation, proceed to the troubleshooting procedures (Paragraph 5-51). After troubleshooting and repair (Paragraph 5-59), perform any necessary adjustments and calibrations (Paragraph 5-61). Before returning the power supply to normal operation, repeat the performance check to ensure that the fault has been properly corrected and that no other faults exist. Before doing any maintenance checks, turn-on power supply, allow a half-hour warm-up, and read the general information regarding measurement techniques (Paragraph 5-6).

### 5-3 HIGH VOLTAGE PRECAUTIONS

5-4 With the supply operating normally and neither output grounded to the chassis, there are many high voltage points within the chassis that are dangerous to personnel. The potentials vary from several hundred to 3000 volts and are dependent on the setting of the VOLTAGE thumbwheel switches. Therefore, always observe the following caution:

#### CAUTION

Connect the positive output to ground (chassis) before removing the covers to perform maintenance. This reduces the number of internal points with dangerous potentials.

5-5 With the positive terminal connected to chassis, only the points illustrated in Figure 5-1 are at a high potential with respect to the chassis.

### 5-6 MEASUREMENT TECHNIQUES

5-7 All measurements given in this manual are with a negative power supply output (positive terminal grounded to chassis). When measuring performance of the power supply it is important that the connection to the output terminal does not introduce additional resistance. For voltage measurements, use a T-connector at the negative output terminal and connect the load to one output of the T-connector and the measuring device to the other output of the T-connector. For current measurements, connect a four-terminal current monitoring resistor in series with the load resistor and connect both to one output of the T-connector. Connect the measuring device across the current monitoring resistor.

5-8 When using an oscilloscope, ground the case at the same ground point as the grounded terminal of the power supply. Make certain that the case is not also grounded by some other means (power cord). Connect both oscilloscope input leads to the power supply ground and check that the oscilloscope is not exhibiting a ripple or transient due to ground loops, pick-up or other means.

### 5-9 TEST EQUIPMENT REQUIRED

5-10 Table 5-1 lists the test equipment required to perform the various procedures described in this section.

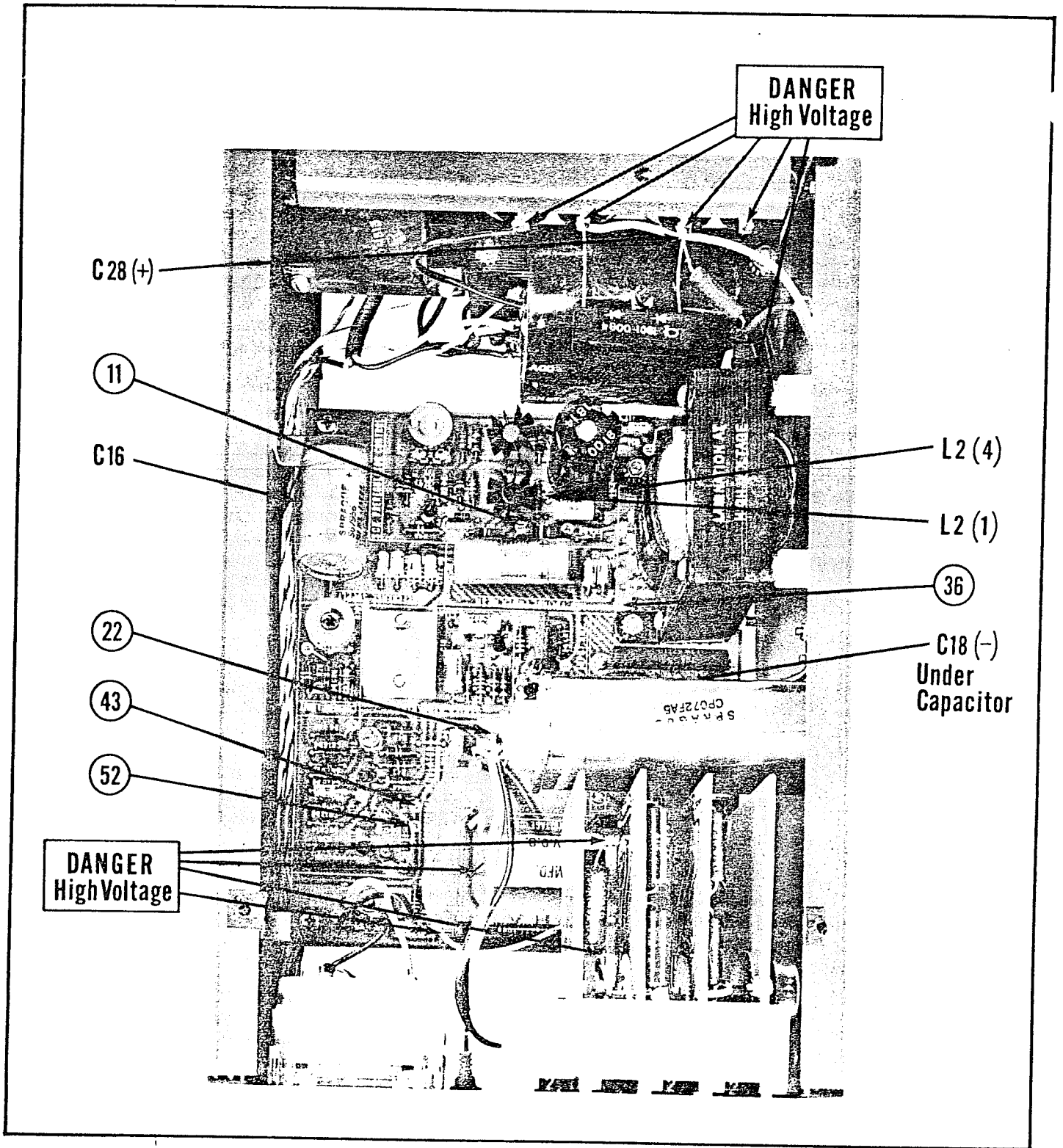

Figure 5-1. High Voltage and Troubleshooting Location Diagram

Table 5-1. Test Equipment

Type	Required Characteristics	Use	Recommended Model
AC Voltmeter	Accuracy: 2%. Sensitivity: 1mV full scale (min.).	Measure AC voltages	Ⓢ 403 B
Variable Voltage Transformer	Range: 90-130 volts. Equipped with voltmeter accurate within 1 volt, 1 KW rating.	Vary and measure AC input voltage	---
Oscilloscope	Sensitivity: 100 $\mu$ V/cm. Differential Input	Measure ripple and transient response	Ⓢ 140 A plus 1400 A Plug-in, 1402A Plug-in for spike measurement only.
Differential Voltmeter	Sensitivity: 1mV full scale (min.).	Measure regulation; Calibrate meter	Ⓢ 3420 See Note
Repetitive Load Switch	Rate: 60-400 Hz, 2 $\mu$ sec rise and fall time, 250V, 1A.	Measure transient	See Figure 5-7
Resistive Load	500K, 18W	Power supply load	---
Resistor	1 K $\Omega$ , $\pm$ 1% 2W non-inductive.	Measure impedance	---
Multimeter	Accuracy 1%	Measure output current and DC voltages	Ⓢ 412 A
Capacitor	500 $\mu$ fd, 50vdcw	Measure impedance	---
Resistor	200K, 1/2W	Measure impedance	---
Oscillator	5 Hz - 600 kHz. Accuracy: 2% Output: 10vrms	Measure impedance	Ⓢ 200 CD
Controlled-Temperature Oven	0-50 $^{\circ}$ C	Measure temperature stability	---
Resistance Box	0-100K $\Omega$ . Accuracy: 0.1% + 1 $\Omega$ . Make-before-break contacts.	Measure programming coefficients	Ⓢ Model 6931A
Capacitor	1 $\mu$ f, 1600wvdc	Measure ripple and noise	---
Voltage Divider	100: 1, up to 4KV, 0.01% Accuracy	Load regulation. Line regulation	Keithley Instruments, Inc. Model 6601A

## NOTE

A satisfactory substitute for a differential voltmeter is to arrange a reference voltage source and null detector as shown in Figure 5-2. The reference voltage source is adjusted so that the voltage difference between the supply being measured and the reference voltage will have the required resolution for the measurement being made. The voltage difference will be a function of the null detector that is used. Examples of satisfactory null detectors are: Ⓢ 419A null detector, a dc coupled oscilloscope utilizing differential input, or a 50mV meter movement with a 100 division scale. For the latter, a 2mV change in voltage will result in a meter deflection of four divisions.

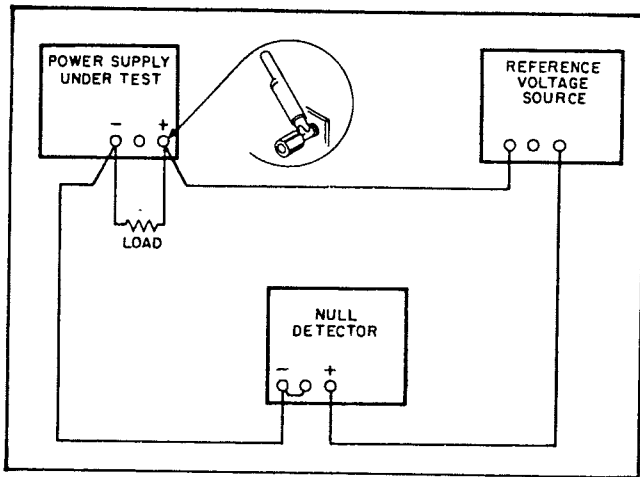

Figure 5-2. Differential Voltmeter Substitute Test Setup

**CAUTION**

Care must be exercised when using an electronic null detector in which one input terminal is grounded to avoid ground loops and circulating currents.

**5-11 PERFORMANCE TEST**

5-12 The following test can be used as an incoming inspection check and appropriate portions of the test can be repeated either to check the operation of the instrument after repairs or for periodic preventive maintenance tests.

5-13 The performance check is made using a 115-volt, 60-Hz (cps), single-phase input power source. The performance check is normally made at a constant ambient room temperature. The temperature range specification can be verified by doing the performance check (except temperature stability check) at a controlled temperature of 0°C and at a controlled temperature of 50°C. If the correct result is not obtained for a particular check, do not adjust any controls; proceed to troubleshooting.

**5-14 RATED OUTPUT, METER, AND OUTPUT CONTROLS ACCURACY**

5-15 Voltage. To check the accuracy of the output voltage, front panel voltmeter, and front panel voltage controls, proceed as follows:

a. Connect the differential voltmeter, load resistor, and the attenuator to the power supply as illustrated in Figure 5-3. Load resistance is 500K ohms, 18 watts.

b. Turn the front panel VOLTAGE thumbwheel controls until the front panel voltmeter indicates exactly 3000Vdc.

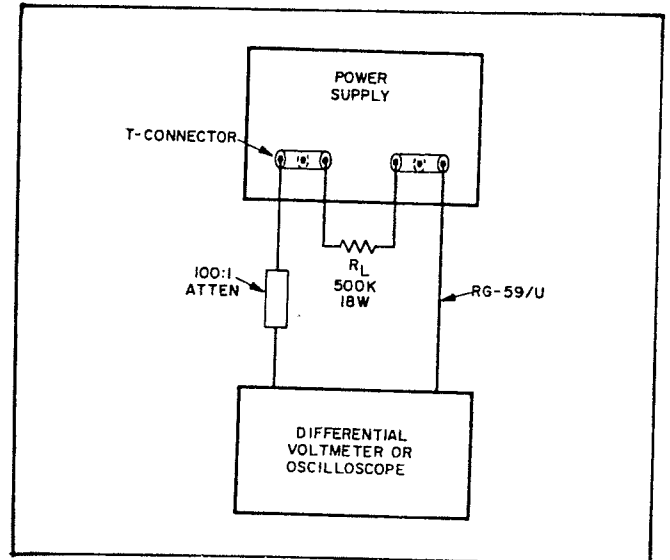

Figure 5-3. Line and Load Regulation, Test Setup

c. The differential voltmeter should indicate  $30 \pm 0.6$ Vdc.

5-16 Current. To check the output current capability of the supply, proceed as follows:

a. Connect the multimeter (set to the 10mA position) or another milliammeter in series with a 500K, 18W load resistance, and attach the series combination to the output terminals.

b. Adjust the VOLTAGE thumbwheel controls until the front panel voltmeter indicates 3000Vdc.

c. The multimeter should indicate 6mA.

**5-17 LOAD REGULATION**

Definition: The change  $\Delta E_{OUT}$  in the static value of DC output voltage resulting from a change in load resistance from open circuit to a value which yields maximum rated output current (or vice versa).

5-18 To check constant voltage load regulation, proceed as follows:

a. Connect differential voltmeter, load resistor and attenuator to the power supply as illustrated in Figure 5-3.

b. Turn the front panel VOLTAGE thumbwheel controls until the front panel voltmeter indicates exactly 3000 volts.

c. Read and record voltage indicated on differential voltmeter.

d. Disconnect load resistor.

e. Reading on differential voltmeter should not vary from reading recorded in step c by more than 3mV.

### 5-19 LINE REGULATION

Definition: The change,  $\Delta E_{OUT}$ , in the static value of DC output voltage resulting from a change in AC input voltage over the specified range from low line (usually 105 volts) to high line (usually 125 volts), or from high line to low line.

5-20 To check constant voltage line regulation, proceed as follows:

- a. Connect variable auto-transformer between input power source and power supply power input.
- b. Connect differential voltmeter, load resistor, and attenuator as illustrated in Figure 5-3.
- c. Adjust variable auto-transformer for 105 Vac input.
- d. Adjust front panel VOLTAGE thumbwheel controls until the front panel voltmeter indicates exactly 3000Vdc.
- e. Read and record voltage indicated on differential voltmeter.
- f. Adjust variable auto transformer for 125 Vac input.
- g. Reading on differential voltmeter should not vary from reading recorded in step e by more than 3mV.

### 5-21 RIPPLE AND NOISE

Definition: The residual AC voltage which is superimposed on the DC output of a regulated power supply. Ripple and noise may be specified and measured in terms of its RMS or (preferably) peak-to-peak value.

5-22 Ripple and noise measurement can be made at any input AC line voltage combined with any DC output voltage and load current within rating.

5-23 The amount of ripple and noise that is present on the power supply output is measured either in terms of the RMS or (preferably) peak-to-peak value. The peak-to-peak measurement is particularly important for applications where noise spikes could be detrimental to a sensitive load, such as logic circuitry. The RMS measurement is not an ideal representation of the noise, since fairly high output noise spikes of short duration could be present in the ripple and not appreciably increase the RMS value.

5-24 The technique used to measure high frequency noise or "spikes" on the output of a power supply is more critical than the low frequency ripple and noise measurement technique; therefore the former is discussed separately in Paragraph 5-32.

5-25 Ripple and Noise Measurements. Figure 5-4A shows an incorrect method of measuring p-p ripple. Note that a continuous ground loop exists from the third wire of the input power cord of the supply to the third wire of the input power cord of the oscilloscope via the grounded power supply case, the wire between the negative output terminal of the power supply and the vertical input of the scope, and the grounded scope case. Any ground current circulating in this loop as a result of the difference in potential  $E_G$  between the two ground points causes an IR drop which is in series with the scope input. This IR drop, normally having a 60Hz line frequency fundamental, plus any pickup on the unshielded leads interconnecting the power supply and scope, appears on the face of the CRT. The magnitude of this resulting noise signal can easily be much greater than the true ripple developed between the plus and minus output terminals of the power supply, and can completely invalidate the measurement.

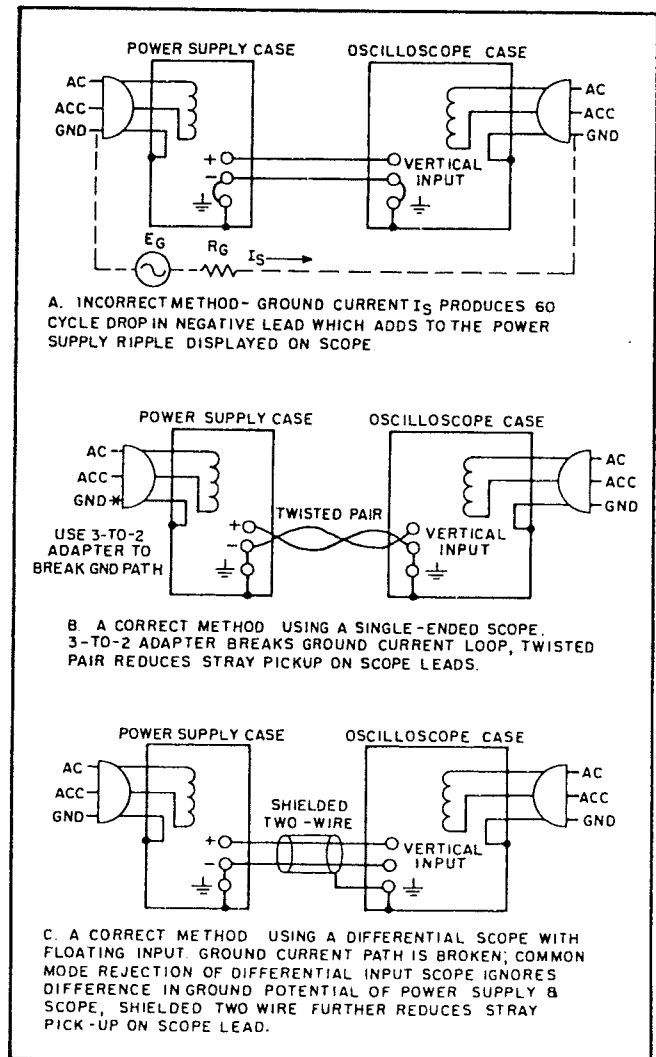

Figure 5-4. Ripple and Noise Test Setup

5-26 The same ground current and pickup problems can exist if an RMS voltmeter is substituted in place of the oscilloscope in Figure 5-4. However, the oscilloscope display, unlike the true RMS meter reading, tells the observer immediately whether the fundamental period of the signal displayed is 8.3 milliseconds (1/120 Hz) or 16.7 milliseconds (1/60 Hz). Since the fundamental ripple frequency present on the output of an  $\phi$  supply is 120 Hz (due to full-wave rectification), an oscilloscope display showing a 120 Hz fundamental component is indicative of a "clean" measurement setup, while the presence of a 60 Hz fundamental usually means that an improved setup will result in a more accurate (and lower) value of measured ripple.

5-27 Figure 5-4B shows a correct method of measuring the output ripple of a constant voltage power supply using a single-ended scope. The ground loop path is broken with a 3 to 2 adapter in series with the power supply's AC line plug. Notice, however, that the power supply case is still connected to ground via the power supply output terminals, the leads connecting these terminals to the scope terminals, the scope case and the third wire of the power supply cord.

5-28 Either a twisted pair or (preferably) a shielded two-wire cable should be used to connect the output terminals of the power supply to the vertical input terminals of the scope. When using a twisted pair, care must be taken that one of the two wires is connected both to the grounded terminal of the power supply and the grounded input terminal of the oscilloscope. When using shielded two-wire, it is essential for the shield to be connected to ground at one end only so that no ground current will flow through this shield, thus inducing a noise signal in the shielded leads.

5-29 To verify that the oscilloscope is not displaying ripple that is induced in the leads or picked up from the grounds, the (+) scope lead should be shorted to the (-) scope lead at the power supply terminals. The ripple value obtained when the leads are shorted should be subtracted from the actual ripple measurement.

5-30 In most cases, the single-ended scope method of Figure 5-4B will be adequate to eliminate non-real components of ripple and noise so that a satisfactory measurement may be obtained. However, in more stubborn cases, or in measurement situations where it is essential that both the power supply case and the oscilloscope case be connected to ground (e. g. if both are rack-mounted), it may be necessary to use a differential scope with floating input as shown in Figure 5-4C. If desired, two single conductor shielded cables may be substituted in place of the shielded two-wire cable with equal success. Because of its common mode rejection, a differential oscillo-

scope displays only the difference in signal between its two vertical input terminals, thus ignoring the effects of any common mode signal introduced because of the difference in the AC potential between the power supply case and scope case. Before using a differential input scope in this manner, however, it is imperative that the common mode rejection capability of the scope be verified by shorting together its two input leads at the power supply and observing the trace on the CRT. If this trace is a straight line, the scope is properly ignoring any common mode signal present. If this trace is not a straight line, then the scope is not rejecting the ground signal and must be realigned in accordance with the manufacturer's instructions until proper common mode rejection is attained.

5-31 To check the ripple and noise output, proceed as follows:

a. Connect the oscilloscope or RMS voltmeter as shown in Figures 5-4B or 5-4C. In addition, connect the high voltage protection network, illustrated in Figure 5-5, in series with the power supply output. In this network, the diodes clamp the input to the oscilloscope in the event that the power supply is rapidly turned up or down. The 50 ohm resistor limits the current through the diodes. The 5Meg resistor is a bleeder to discharge the 0.1 $\mu$ f capacitor which is a 3000Vdc blocking capacitor. A good quality 3000Vdc blocking capacitor can be used in place of the protection network; however, if the capacitor becomes leaky or in cases where the power supply output voltage is rapidly increased or decreased, the oscilloscope input could be damaged.

b. Adjust VOLTAGE control until front panel meter indicates maximum rated output voltage.

c. The observed ripple and noise should be less than 2mV rms and 5mV p-p.

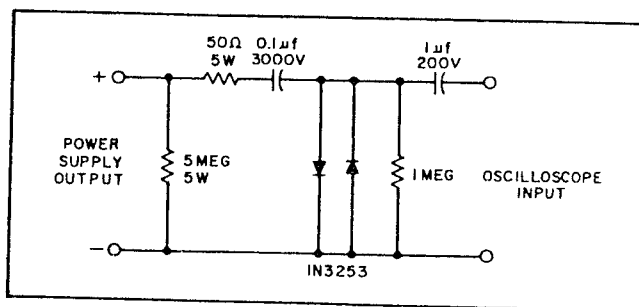

Figure 5-5. High Voltage Protection Network

5-32 Noise Spike Measurement. When a high frequency spike measurement is being made, an instrument of sufficient bandwidth must be used; an oscilloscope with a bandwidth of 20 MHz or more is adequate. Measuring noise with an instrument that has insufficient bandwidth may conceal high frequency spikes detrimental to the load.

5-33 The test setups illustrated in Figures 5-4A and 5-4B are generally not acceptable for measuring spikes; a differential oscilloscope is necessary. Furthermore, the measurement concept of Figure 5-4C must be modified if accurate spike measurement is to be achieved:

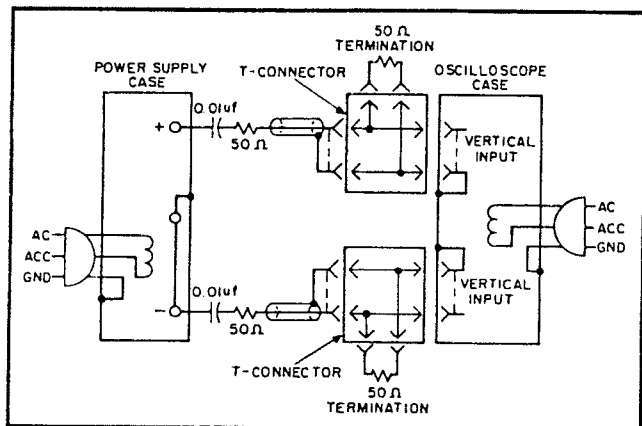

Figure 5-6. Noise Spikes Test Setup

1. As shown in Figure 5-6, two coax cables, must be substituted for the shielded two-wire cable. In addition a high voltage protection network (Figure 5-5) as described in paragraph 5-31 should be connected in series with the power supply output.

2. Impedance matching resistors must be included to eliminate standing waves and cable ringing, and the capacitors must be connected to block the DC current path.

3. The length of the test leads outside the coax is critical and must be kept as short as possible; the blocking capacitor and the impedance matching resistor should be connected directly from the inner conductor of the cable to the power supply terminals.

4. Notice that the shields of the power supply end of the two coax cables are not connected to the power supply ground, since such a connection would give rise to a ground current path through the coax shield, resulting in an erroneous measurement.

5. The measured noise spike values must be doubled, since the impedance matching resistors constitute a 2-to-1 attenuator.

6. The noise spikes observed on the oscilloscope should be less than 2.5mV p-p.

5-34 The circuit of Figure 5-6 can also be used for the normal measurement of low frequency ripple and noise; simply remove the four terminating resistors and the blocking capacitors and substitute a higher gain vertical plug-in in place of the wide-band plug-in required for spike measurements. Notice that with these changes, Figure 5-6 becomes a two-cable version of Figure 5-4C.

### 5-35 TRANSIENT RECOVERY TIME

Definition: The time "X" for output voltage recovery to within "Y" millivolts of the nominal output voltage following a "Z" amp step change in load current — where:

"Y" is specified separately for each model but is generally of the same order as the load regulation specification. The nominal output voltage is defined as the DC level half way between the static output voltage before and after the imposed load change, and

"Z" is the specified load current change, normally equal to the full load current rating of the supply.

5-36 Transient recovery time may be measured at any input line voltage combined with any output voltage and load current within rating.

5-37 Reasonable care must be taken in switching the load resistance on and off. A hand-operated switch in series with the load is not adequate, since the resulting one-shot displays are difficult to observe on most oscilloscopes, and the arc energy occurring during switching action completely masks the display with a noise burst. Transistor load switching devices are expensive if reasonably rapid load current changes are to be achieved.

A mercury-wetted relay, as connected in the load switching circuit of Figure 5-7 should be used for loading and unloading the supply. When this load switch is connected to a 60 Hz AC input, the mercury-wetted relay will open and close 60 times per second. Adjustment of the 25K control permits adjustment of the duty cycle of the load current switching and reduction in jitter of the oscilloscope display.

5-38 To check the transient recovery time, proceed as follows:

- a. Connect test setup as shown in Figure 5-7.
- b. Set the VOLTAGE thumbwheel switches for 90Vdc.
- c. Close the line switch on the repetitive load switch setup.
- d. Set the oscilloscope for internal sync and lock on either the positive or negative load transient spike.
- e. Set the vertical input of the oscilloscope for AC coupling so that small DC level changes in the output voltage of the power supply will not cause the display to shift.
- f. Adjust the vertical centering on the scope so that the tail ends of the no load and full load waveforms are symmetrically displaced about



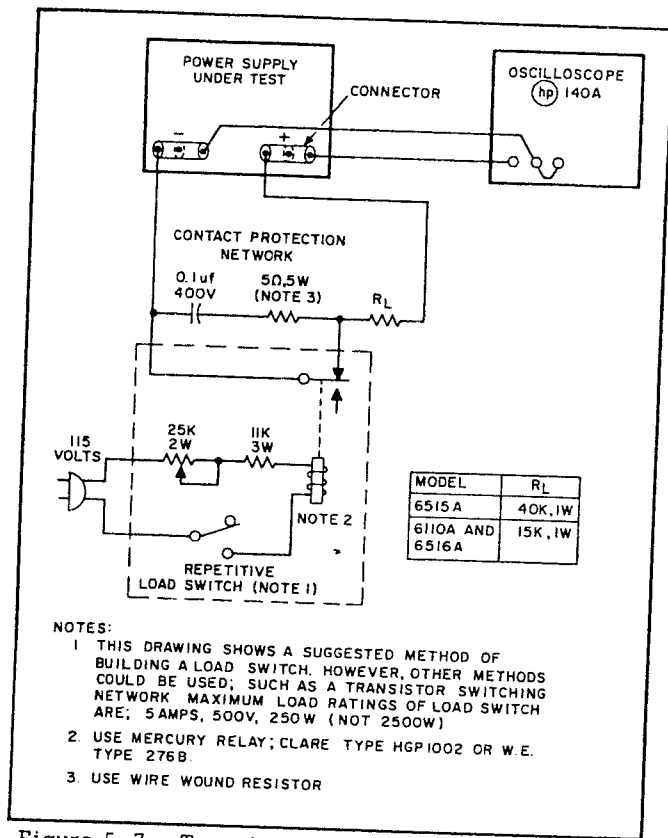

Figure 5-7. Transient Recovery Time, Test Setup

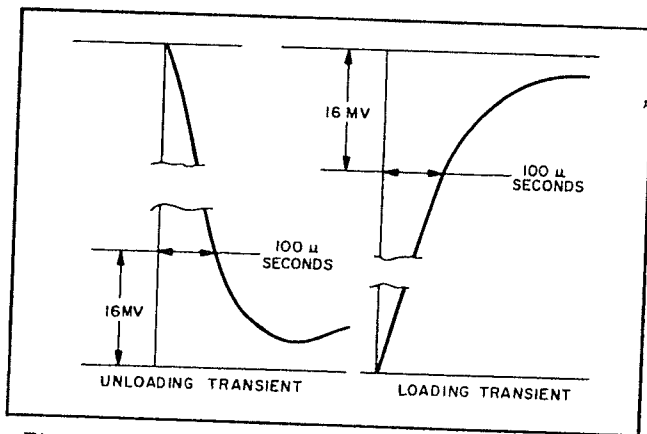

Figure 5-8. Transient Recovery Time Waveforms

the horizontal center line of the oscilloscope. This center line now represents the nominal output voltage defined in the specification.

g. Adjust the horizontal positioning control so that the trace starts at a point coincident with a major graticule division. This point is then representative of time zero.

h. Increase the sweep rate so that a single transient spike can be examined in detail.

i. Adjust the sync controls separately for the positive and negative going transients so that

not only the recovery waveshape but also as much as possible of the rise time of the transient is displayed.

j. Starting from the major graticule division representative of time zero, count to the right 100  $\mu$ sec and vertically 16mV. Recovery should be within these tolerances as illustrated in Figure 5-8.

### 5-39 OUTPUT IMPEDANCE

Definition: At any given frequency of load change,  $\Delta E_{OUT}/\Delta I_{OUT}$ .

The definition applies only for a sinusoidal load disturbance, unless, of course, the measurement is made at zero frequency (DC). The output impedance of an ideal constant voltage power supply would be zero at all frequencies, while the output impedance for an ideal constant current power supply would be infinite at all frequencies.

5-40 The output impedance of a power supply is normally not measured, since the measurement of transient recovery time reveals both the static and dynamic output characteristics with just one measurement. The output impedance of a power supply is commonly measured only in those cases where the exact value at a particular frequency is of engineering importance.

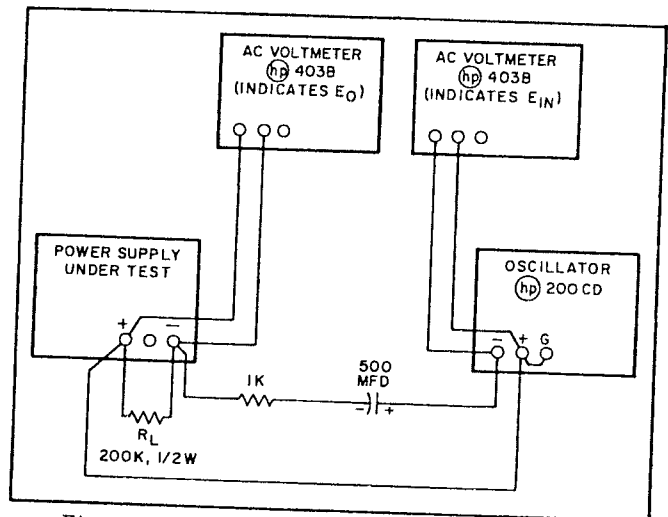

Figure 5-9. Output Impedance, Test Setup

5-41 To check the output impedance, proceed as follows:

a. Connect the test setup as shown in Figure 5-9. The best method of connecting the load resistor, oscillator, and AC voltmeter to the power supply is

with two tee connectors on each power supply terminal. Clip lead connections can be used in lieu of the tee connectors providing that all connections are made directly to the power supply and lead lengths are short.

b. Adjust front panel VOLTAGE thumbwheel switches until the front panel voltmeter indicates 200Vdc.

c. Set AMPLITUDE control on oscillator to 10 volts ( $E_{IN}$ ), and FREQUENCY control to 30 Hz (cps).

d. Record voltage across output terminals of the supply ( $E_O$ ) as indicated on AC voltmeter.

e. Calculate the output impedance by the following formula:

$$Z_{out} = \frac{E_O R}{E_{in} - E_O}$$

where  $E_O$  = rms voltage across power supply output terminals

$R = 1000$  ohms

$E_{in} = 10$  volts

f. The output impedance ( $Z_{out}$ ) should be less than 32 ohms.

g. Using formula of step e, calculate output impedance at frequencies of 100 kHz and 1 MHz. Values should be less than 8 ohms and 2 ohms, respectively.

#### 5-42 TEMPERATURE COEFFICIENT

Definition: The change in output voltage per degree Centigrade change in the ambient temperature under conditions of constant input AC line voltage, output voltage setting, and load resistance.

5-43 The temperature coefficient of a power supply is measured by placing the power supply in an oven and varying it over any temperature span within its rating. (Most power supplies are rated for operation from 0°C to 50°C.) The power supply must be allowed to thermally stabilize for a sufficient period of time at each temperature of measurement.

5-44 The temperature coefficient specified is the maximum temperature-dependent output voltage change which will result over any 5°C interval. The differential voltmeter or digital voltmeter used to measure the output voltage change of the supply should be placed outside the oven and should have a long term stability adequate to insure that its drift will not affect the overall measurement accuracy.

5-45 To check the temperature coefficient, proceed as follows:

- Connect the load resistance, attenuator, and differential voltmeter as illustrated in Figure 5-3.
- Adjust front panel VOLTAGE thumbwheel

switches until the front panel voltmeter indicates 3000 Vdc.

c. Insert the power supply into the temperature — controlled oven (differential voltmeter remains outside oven). Set the temperature to 30°C and allow 30 minutes warm-up.

d. Record the differential voltmeter indication.

e. Raise the temperature to 40°C and allow 30 minutes warm-up.

f. The differential voltmeter indication should change by less than 6mV from indication recorded in step d.

#### 5-46 OUTPUT STABILITY

Definition: The change in output voltage for the first eight hours following a 30 minute warm-up period. During the interval of measurement all parameters, such as load resistance, ambient temperature, and input line voltage are held constant.

5-47 This measurement is made by monitoring the output of the power supply on a differential voltmeter or digital voltmeter over the stated measurement interval; a strip chart recorder can be used to provide a permanent record. A thermometer should be placed near the supply to verify that the ambient temperature remains constant during the period of measurement. The supply should be put in a location immune from stray air currents (open doors or windows, air conditioning vents); if possible, the supply should be placed in an oven which is held at a constant temperature. Care must be taken that the measuring instrument has a stability over the eight hour interval which is at least an order of magnitude better than the stability specification of the power supply being measured. Typically, a supply may drift less over the eight hour measurement interval than during the 1/2 hour warm-up period.

Stability measurement can be made while the supply is remotely programmed with a fixed wire-wound resistor, thus avoiding accidental changes in the front panel setting due to mechanical vibration or "knob-twiddling."

5-48 To check the output stability, proceed as follows:

- Connect the load resistance, attenuator, and differential voltmeter as illustrated in Figure 5-3.
- Adjust front panel VOLTAGE RANGE switch and VERNIER until the differential voltmeter indicates 30Vdc (power supply output is 3000Vdc).
- Allow 30 minutes warm-up then record the differential voltmeter indication.
- After 8-hours, differential voltmeter should change by less than 15mV from indication recorded in step c.

5-49 CURRENT LIMIT

5-50 To check the current limiting characteristics of the supply, proceed as follows:

- a. Connect a milliammeter across the output of the supply.
- b. Turn on the supply and increase the output voltage until the milliammeter indicates 6mA.
- c. Check that the supply is not in current limit by examining the output ripple. The ripple will be very high — much greater than 400µV — if the supply is in current limit.
- d. Increase the output voltage to 3000V and ensure that the output current does not exceed 8mA.

5-51 TROUBLESHOOTING

5-52 Before attempting to troubleshoot this instrument, ensure that the fault is with the instrument and not with an associated circuit. The performance test (Paragraph 5-11) enables this to be determined without having to remove the instrument from the cabinet.

5-53 A good understanding of the principles of operation is a helpful aid in troubleshooting, and it is recommended that the reader review Section IV of the manual before attempting to troubleshoot the unit in detail. Once the principles of operation are understood, refer to the overall troubleshooting procedures in paragraph 5-55 to locate the symptom and probable cause.

NOTE

The normal voltages shown on the schematic diagram at the rear of the

manual are positioned adjacent to the applicable test points (identified by encircled numbers on the schematic and printed wiring boards).

5-54 Once the defective component has been located (by means of visual inspection or trouble analysis) correct it and re-conduct the performance test. If a component is replaced, refer to the repair and replacements and adjustment and calibration paragraphs in this section.

5-55 OVERALL TROUBLESHOOTING PROCEDURE

5-56 To locate the cause of trouble follow steps 1, 2, and 3 in sequence.

CAUTION

Connect the positive output to ground (chassis) before troubleshooting with the supply turned on. This reduces the number of internal points with dangerous potentials to those indicated in Figure 5-1.

(1) Check for obvious troubles such as open fuse, defective power cord, input power failure, or defective voltage or current meter. Next remove the top and bottom covers (each held by four retaining screws) and inspect for open connections, charred components, etc. If the trouble source cannot be detected by visual inspection, proceed with step 2

(2) In almost all cases, the trouble can be caused by the DC bias or reference voltages; thus, it is a good practice to check voltages in Table 5-2, before proceeding with step 3. Refer to Figure 5-1 for test point locations.

Table 5-2. Bias, Reference, and Rectifier Voltages  
(Refer to Figure 5-1 for test point locations)

Step	Meter Common	Meter Positive	Normal Vdc	Normal Ripple (P-P)	Probable Cause
1	C16(-)	C16(+)	56V	0.5V	CR22, CR23, CR24, CR25, C16
2	C16(-)	+S	-0.7	1mV	CR1, CR2
3	+S	43	15V	2mV	Q14, Q15
4	+S	52	40V	5mV	Q12, VR4
5	36	11	175V	1V	CR29, CR30, C19, R54
6	36	22	327V	6V	CR33-CR36, C18, R40

(3) Examine the following list to determine your symptom, then check the probable cause.

<u>Symptom</u>	<u>Probable Cause</u>
Low output or no output voltage	Insure that the front panel meter is not defective, then refer to paragraph 5-57.
High output voltage	Insure that the front panel meter is not defective, then refer to paragraph 5-57.

#### CAUTION

Never set the output voltage controls to zero volts when there is high or low output voltage; damage to the voltage controls could result.

Erratic output voltage. (The needle on the output voltage meter wavers slightly, or an oscilloscope connected to the output displays erratic ripple.)	Same as low output symptom; refer to paragraph 5-57.
Inability to reach zero output voltage $\pm 1\text{mV}$ .	a. Check output voltage zero adjustment, paragraph 5-65. b. Output voltage control R200 defective. c. Amplifier Q1 defective.
Oscillates	C20, R20, C11, R25 defective.
Slow drift	a. Measuring equipment. b. Reference diode VR1. c. Q16 d. Insufficient warm-up time (should be 30 minutes).
Random instability	High voltage control circuit defective. Refer to Table 5-3 step 8
a. Large output voltage transients (output reductions of 1V or more)	
b. Large output voltage transients (output increases of 1V or more).	High voltage control circuit defective. Refer to Table 5-4, step 6.

c. Small output voltage transients (output changes of 10-30 mV). VR1 defective, voltage thumbwheel switches noisy, 1V thumbwheel control R200 noisy

High Ripple

- Check operating set-up for ground loops.
- If output floating, connect  $1\mu\text{f}$  capacitor between output and ground
- Check for excessive internal ripple; refer to Table 5-2.
- Ensure that supply is not current limiting under loaded conditions. Check that test point (40) is approx.  $+12\text{V}$ . Current limit circuit defective or misadjusted (refer to paragraph 5-68)

Poor Transient Recovery Time

C20, R20, C11, R25 defective.

Output Voltage Inaccuracy

- Set output voltage controls to zero. Output voltage should read  $0\text{V} \pm 10\text{mV}$ ; if not, perform adjustment given in paragraph 5-66.
- Slowly rotate each thumbwheel switch a step at a time, and record the output voltage. The step changes should be within  $\pm 0.1\%$ . A deviation in any step indicates that the associated resistor is defective.

5-57 Regulating Loop Troubles. If the voltages in Table 5-2 have been checked to eliminate the reference, bias and rectifier circuits as a source of trouble; the malfunction is caused by either the low or high voltage regulating loops. If any component in a feedback loop is defective, measurements made anywhere in the loop may appear abnormal. Under these circumstances it is very difficult to separate cause from effect with the loop closed. As described in Tables 5-3 and 5-4, the trouble is isolated to either the high or low voltage regulating loop. The loop is opened, and the conduction and cutoff capability of each stage is checked as follows:

1. Shorting the emitter to collector of a transistor simulates saturation, or the full ON condition.

2. Shorting the emitter to base of a transistor cuts it off, and simulates an open circuit between emitter and collector.

5-58 Although a logical first choice might be to break the loop somewhere near its mid-point, and then perform successive subdividing test, it is more useful to trace the loop from the series regulator backwards a stage at a time, since loop failures occur more often at the higher power levels.

Table 5-3. Low Output Voltage Troubleshooting

Step	Action	Response	Probable Cause
1	To isolate the fault to either the high voltage circuits or the low voltage feedback loop, measure the voltage between the collector (case) of Q11 and +S	a. Approximately 160V b. Approximately 0V	a. Low voltage feedback loop. Proceed to step 2 b. High voltage circuits. Proceed to step 7
2	Once it is determined that the low voltage loop is defective, the high voltage control circuit should be disabled by connecting a jumper between L2(4) and L2(1) as illustrated in Figure 5-1. Since this places a reverse voltage across capacitors C27 and C28, a jumper must be connected from the (-) lead of C18 to the (+) lead of C28 as illustrated in Figure 5-1. The low voltage loop should be checked as follows:		
3	To check the operation of the current limit, measure the voltage across CR31. Meter positive on cathode, negative on anode	a. More negative than -.6V b. Approximately +2V	a. Current limit circuit faulty. Check CR31, R44, R45, R70, R26, CR6 b. Proceed to step 3
4	Check turn-on of Q11 and turn-off of Q10 by connecting a jumper between the emitter and base of Q10	a. Output remains low b. Output increases (≈150V)	a. Q10 or Q11 defective; proceed to step 5 b. Remove jumper from Q10 and proceed to step 6
5	Check turn-on of Q11 by opening the collector lead of Q10	a. Output remains low b. Output increases	a. Q11 or associated components defective b. Q10 or associated components defective
6	Turn off the supply and remove the lead connected to test point (42). Check the resistance of R200 through R224	a. Resistance low b. Resistance correct value	a. Resistor defective b. Q16 or associated components defective
7	To check the high voltage control circuit, set the output VOLTAGE controls to 900V and remove the jumpers from L2(4) - L2(1) and C18-C28. Proceed with step 8.		

Table 5-3. Low Output Voltage Troubleshooting (Continued)

Step	Action	Response	Probable Cause
8	<p>Connect the oscilloscope between test point 11 and +out. Set the oscilloscope for dc coupled input</p>	<p style="text-align: center;">NOTE</p> <p>Waveforms that indicate normal operation of the high voltage control circuit under various line and load conditions are shown on the schematic diagram at the rear of the manual.</p> <div style="text-align: center;">  <p>T. P. ⑪ TO ⊕ 20V/CM 10ms/CM</p> <p>The waveform above indicates a normal condition. Note that the lowest peak does not reach zero volts</p>  <p>T. P. ⑪ TO ⊕ 20V/CM 10ms/CM</p> <p>The waveform above is indicative of poor regulation and erratic output in addition to slightly low output voltage. Note that the lowest peak touches 0V. If the output is very low, the waveform is compressed toward 0V.</p> </div>	<ul style="list-style-type: none"> <li>a. If VR3 is on or blinking, OVERVOLTAGE control R71 should be adjusted (see paragraph 5-70)</li> <li>b. Q17 leaky or shorted</li> <li>c. CR7 or CR40 shorted or leaky</li> <li>d. CR3 or CR4 shorted</li> <li>e. CR41 open or shorted</li> <li>f. T1 or L3 defective.</li> </ul>

Table 5-4. High Output Voltage Troubleshooting

Step	Action	Response	Probable Cause
1	Turn the thumbwheel voltage controls from zero to 600 volts	a. Output voltage is high up to 300V then becomes normal above 300V b. Output voltage is high throughout voltage range	a. Low Voltage Offset circuit defective b. Proceed to step 2
2	To isolate the fault to either the high voltage circuits or the low voltage feedback loop, set the output voltage to 100.0V and disable the high voltage control circuit as described in Table 5-3, step 2	a. Approximately 160V b. Approximately 0V	a. Low voltage feedback Proceed to step 3 b. High voltage circuits Proceed to step 6
3	Check turn-off of Q11 by connecting a jumper between Q10 collector and emitter	a. Output remains high b. Output decreases to 0V	a. Q11 or associated components defective b. Remove jumper on Q10 and proceed to step 4
4	Check turn-on of Q10 by removing Q16 collector lead	a. Output remains high b. Output decreases to 0V	a. Q10 or associated components defective b. Reconnect Q16 and proceed to step 5
5	Turn off the supply and remove lead from test point 42. Check the resistance from that lead to (-) output	a. More than $100\Omega \pm 1\%$ b. $100\Omega \pm 1\%$	a. Open in R200-R224 network b. Check Q16 or associated circuitry
6	To check the high voltage control circuit, set the output VOLTAGE controls to 900V and remove the jumpers from L4-L5 and C18-C28. Proceed with step 7		
NOTE			
Waveforms that indicate normal operation of the high voltage control circuit under various line and load conditions are shown on the schematic diagram at the rear of the manual.			

Table 5-4. High Output Voltage Troubleshooting (Continued)

Step	Action	Response	Probable Cause
7	<p>Connect the oscilloscope between test point 36 and + out. Set the oscilloscope for dc coupled input</p>	<div data-bbox="690 231 1023 504" data-label="Figure"> </div> <p data-bbox="803 514 933 556">T.P. 36 TO (+) 20V/CM 10ms/CM</p> <p data-bbox="698 619 998 766">The waveform above indicates a normal condition. Note that the highest peak does not reach zero volts</p> <div data-bbox="682 840 1023 1113" data-label="Figure"> </div> <p data-bbox="803 1123 933 1165">T.P. 36 TO (+) 20V/CM 10ms/CM</p> <p data-bbox="698 1218 998 1470">The waveform above is indicative of high output voltage. Note that the peaks reach and are clipped at zero volts. Extremely high output voltage produces a waveform that is compressed at zero volts</p>	<ul style="list-style-type: none"> <li>a. CR39 or R77 open</li> <li>b. CR3 or CR4 open</li> <li>c. T1 control winding terminals 5-7 open. Resistance between collector of CR8 and T1 term 6 should be <math>25\Omega</math>. Resistance between collector of CR40 and T1 term 6 should be <math>25\Omega</math></li> <li>d. R76 or Q17 open</li> <li>e. CR7 or CR40 not firing.</li> </ul>

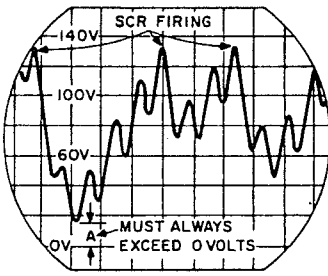
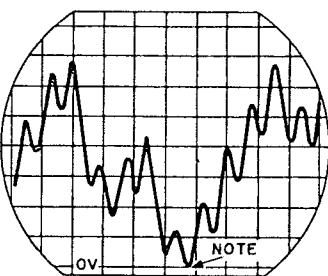
5-59 REPAIR AND REPLACEMENT

5-60 Before servicing a printed wiring board,

refer to Figure 5-10, which describes the basic techniques in replacing components on a printed wiring board.



Excessive heat or pressure can lift the copper strip from the board. Avoid damage by using a low power soldering iron (50 watts maximum) and following these instructions. Copper that lifts off the board should be cemented in place with a quick drying acetate base cement having good electrical insulating properties.

A break in the copper should be repaired by soldering a short length of tinned copper wire across the break.

Use only high quality rosin core solder when repairing etched circuit boards. NEVER USE PASTE FLUX. After soldering, clean off any excess flux and coat the repaired area with a high quality electrical varnish or lacquer.

When replacing components with multiple mounting pins such as tube sockets, electrolytic capacitors, and potentiometers, it will be necessary to lift each pin slightly, working around the components several times until it is free.

**WARNING:** If the specific instructions outlined in the steps below regarding etched circuit boards without eyelets are not followed, extensive damage to the etched circuit board will result.

1. Apply heat sparingly to lead of component to be replaced. If lead of component passes through an eyelet in the circuit board, apply heat on component side of board. If lead of component does not pass through an eyelet, apply heat to conductor side of board.

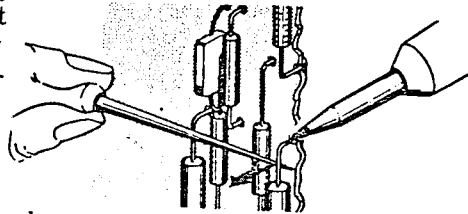

2. Reheat solder in vacant eyelet and quickly insert a small awl to clean inside of hole.

If hole does not have an eyelet, insert awl or a #57 drill from conductor side of board.

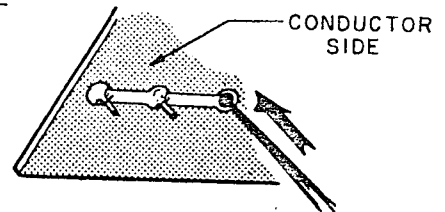

3. Bend clean tinned lead on new part and carefully insert through eyelets or holes in board.

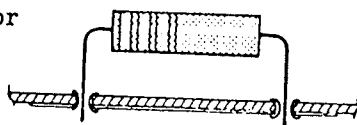

4. Hold part against board (avoid overheating) and solder leads.

Apply heat to component leads on correct side of board as explained in step 1.

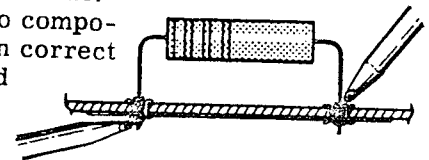

In the event that either the circuit board has been damaged or the conventional method is impractical, use method shown below. This is especially applicable for circuit boards without eyelets.

1. Clip lead as shown below.

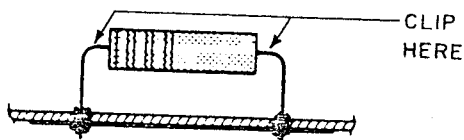

2. Bend protruding leads upward. Bend lead of new component around protruding lead. Apply solder using a pair of long nose pliers as a heat sink.

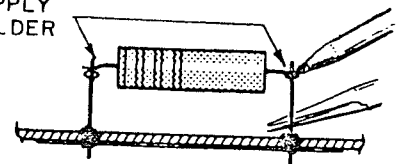

This procedure is used in the field only as an alternate means of repair. It is not used within the factory.

Figure 5-10. Servicing Printed Wiring Boards

## 5-61 ADJUSTMENT AND CALIBRATION

### 5-62 METER ZERO

5-63 Proceed as follows to mechanically zero meter:

- a. Turn off instrument (after it has reached normal operating temperature) and allow 30 seconds for all capacitors to discharge.
- b. Insert sharp pointed object (pen point or awl) into the small indentation near top of round black plastic disc located directly below meter face.
- c. Rotate plastic disc clockwise (cw) until meter reads zero, then rotate ccw slightly in order to free adjustment screw from meter suspension. If pointer moves, repeat steps b and c.

### 5-64 METER ACCURACY ADJUSTMENT

5-65 To adjust the electrical meter accuracy, proceed as follows:

- a. Connect the 100:1 attenuator and the differential voltmeter as illustrated in Figure 5-2.
- b. Adjust the VOLTAGE thumbwheels until the differential voltmeter indicates 30.00 volts.
- c. Adjust R67 until the front panel voltmeter indicates exactly 3000 volts.

### 5-66 OUTPUT VOLTAGE (PROGRAMMING CURRENT) ADJUSTMENT

5-67 To adjust the output voltage, proceed as follows:

- a. Connect the 100:1 attenuator and the differential voltmeter as illustrated in Figure 5-2.
- b. Turn the VOLTAGE thumbwheel switches to 0V.
- c. Remove R51 and R52 and connect the decade box (set to approximately 200 ohms) to the standoff terminal in place of R52.
- d. Adjust the decade box until the differential voltmeter indicates 30.00Vdc.

e. Note the setting of the decade box and connect the next highest value resistor in the R52 position on the circuit board. This resistor should be a 1%, 1/4W Metal Film type with a temperature coefficient not greater than 100 ppm per degree centigrade.

f. Readjust the decade box until the differential voltmeter again reads 30.00Vdc.

g. Note the setting of the decade box and connect an equal value resistor to the standoff terminals for R51. This resistor should be 5%, 1/2W carbon composition.

### 5-68 OUTPUT CURRENT LIMIT ADJUSTMENT

5-69 To adjust the limiting level of the output current, proceed as follows:

- a. Attach the multimeter or a milliammeter to the output terminals of the supply. Set the meter for approximately 10 mA. The internal resistance of the meter is low enough to overload the supply so that the output will current limit.
- b. Set the VOLTAGE thumbwheel switches to 300 volts.
- c. Adjust current limit control R70 until the meter indicates 8.2 mA.

### 5-70 OVERVOLTAGE PROTECTION

5-71 To adjust the overvoltage protection feature so that the output voltage will not exceed 3000V under any circumstances, proceed as follows:

- a. Connect a 500K, 18W load resistor to the output of the supply and connect a Variac to the input.
- b. Turn on the power supply and adjust the Variac for 127Vac.
- c. Set the output VOLTAGE controls for 3000Vdc.
- d. Turn overvoltage potentiometer R71 clockwise until neon light VR3 is on; then turn R71 slowly counterclockwise until VR3 extinguishes.

SECTION VI  
REPLACEABLE PARTS

6-1 INTRODUCTION

6-2 This section contains information for ordering replacement parts.

6-3 Table 6-1 lists parts in the alpha-numerical order of the reference designators and provides the following information:

- a. Description (See list of abbreviations below).
- b. Total quantity used in the instrument.
- c. Manufacturer's name and part number.
- d. The Manufacturer's code number as listed in the Federal Supply Code for Manufacturers H4-1.
- e. The  $\phi$  Stock Number.
- f. The recommended spare parts quantity for complete maintenance of one instrument during one year of isolated service. (Column RS)

6-4 ORDERING INFORMATION

6-5 To order a replacement part, address order or inquiry to your local Hewlett-Packard field office (see lists at rear of this manual for addresses).

6-6 Specify the following information for each part:

- a. Model and complete serial number of instrument.
- b. Hewlett-Packard stock number.
- c. Circuit reference designator.
- d. Description.

6-7 To order a part not listed in the tables, give a complete description of the part and include its function and location.

ABBREVIATIONS

a	= amperes	obd	= order by description
c	= carbon	p	= peak
cer	= ceramic	pc	= printed circuit board
coef	= coefficient	pf	= picofarads = 10 <sup>-12</sup> farads
com	= common	pp	= peak-to-peak
comp	= composition	ppm	= parts per million
conn	= connection	pos	= position(s)
crt	= cathode-ray tube	poly	= polystyrene
dep	= deposited	pot	= potentiometer
elect	= electrolytic	prv	= peak reverse voltage
encap	= encapsulated	rect	= rectifier
f	= farads	rot	= rotary
fxd	= fixed	rms	= root-mean-square
GE	= germanium	s-b	= slow-blow
grd	= ground(ed)	sect	= section(s)
h	= henries	Si	= silicon
Hg	= mercury	sil	= silver
imp	= impregnated	sl	= slide
ins	= insulation(ed)	td	= time delay
K	= kilo = 1000	TiO <sub>2</sub>	= titanium dioxide
lin	= linear taper	tog	= toggle
log	= logarithmic taper	tol	= tolerance
mA	= milli = 10 <sup>-3</sup>	trim	= trimmer
M	= megohms	twt	= traveling wave tube
ma	= milliamperes	var	= variable
$\mu$	= micro = 10 <sup>-6</sup>	w/	= with
mfr	= manufacturer	W	= watts
mtg	= mounting	w/o	= without
my	= mylar	cmo	= cabinet mount only
NC	= normally closed		
Ne	= neon		
NO	= normally open		
nsr	= not separately replaceable		

REFERENCE DESIGNATORS

A	= assembly	Q	= transistor
B	= motor	R	= resistor
C	= capacitor	RT	= thermistor
CR	= diode	S	= switch
DS	= device signaling (lamp)	T	= transformer
E	= misc. electronic part	V	= vacuum tube, neon bulb, photocell, etc.
F	= fuse	X	= socket
J	= jack	XP	= fuseholder
K	= relay	XDS	= lampholder
L	= inductor	Z	= network
M	= meter		
P	= plug		

MANUFACTURERS

AB	Allen-Bradley	Mot	Motorola, Inc.
B	Bendix Corp.	RCA	Radio Corp. of America
Beede	Beede Elec. Instr. Co., Inc.	Reliance	Reliance Mica Corp.
Buss	Bussman Mfg.	Mica	U. S. Semcor
Carling	Carling Elec.	Semcor	Sloan Co.
CTS	CTS Corp.	Sloan	Sprague Elec.
Elco	Elco Corp.	Sprague	Superior Elec.
GE	General Elec.	Superior	Sylvania Elec. Products, Inc.
GI	General Instru.	Sylv.	Texas Instru.
HH	Hardwick-Hindle Co.	TI	Ward Leonard
Kulka	Kulka Electric	WL	

The following code numbers are from the Federal Supply Code for Manufacturers Cataloging Handbooks H4-1 (Name to Code) and H4-2 (Code to Name) and their latest supplements. The date of revision and the date of the supplements used appear at the bottom of each page. Alphabetical codes have been arbitrarily assigned to suppliers not appearing in the H4 handbooks.

CODE NO.	MANUFACTURER	ADDRESS
00629	EBY Sales Co.	New York, N. Y.
00656	Aerovox Corp.	New Bedford, Mass.
00853	Sangamo Electric Company, Ordill Division (Capacitors)	Marion, Ill.
01121	Allen Bradley Co.	Milwaukee, Wis.
01255	Litton Industries, Inc.	Beverly Hills, Calif.
01281	TRW Semiconductors, Inc.	Lawndale, Calif.
01295	Texas Instruments, Inc. Semiconductor- Components Division	Dallas, Texas
01686	RCL Electronics, Inc.	Manchester, N. H.
01930	Amerock Corp.	Rockford, Ill.
02114	Ferroxcube Corp. of America	Saugerties, N. Y.
02660	Amphenol-Borg Electronics Corp.	Broadview, Ill.
02735	Radio Corp. of America, Commercial Receiving Tube and Semiconductor Div.	Somerville, N.J.
03508	G. E. Semiconductor Products Dept.	Syracuse, N. Y.
03797	Eldema Corp.	Compton, Calif.
03877	Transitron Electronic Corp.	Wakefield, Mass.
03888	Pyrofilm Resistor Co.	Cedar Knolls, N.J.
04009	Arrow, Hart and Hegeman Electric Co.	Hartford, Conn.
04072	ADC Electronics, Inc.	Harbor City, Calif.
04213	Caddell-Burns Mfg. Co. Inc.	Mineola, N. Y.
04404	Dymec Division of Hewlett-Packard Co.	Palo Alto, Calif.
04713	Motorola, Inc., Semiconductor Products Division	Phoenix, Arizona
05277	Westinghouse Electric Corp. Semi-Conductor Dept.	Youngwood, Pa.
05347	Ultronix, Inc.	Grand Junction, Colo.
06486	North American Electronics, Inc.	Lynn, Mass.
06540	Amathom Electronic Hardware Co., Inc.	New Rochelle, N. Y.

CODE NO.	MANUFACTURER	ADDRESS
06555	Beede Electrical Instrument Co., Inc.	Penacook, N. H.
06666	General Devices Co., Inc.	Indianapolis, Ind.
06751	Nuclear Corp. of America, Inc., U. S. Semcor Div.	Phoenix, Arizona
06812	Torrington Mfg. Co., West Div.	Van Nuys, Calif.
07137	Transistor Electronics Corp.	Minneapolis, Minn.
07138	Westinghouse Electric Corp. Electronic Tube Div.	Elmira, N.Y.
07263	Fairchild Semiconductor Div. of Fairchild Camera and Instrument Corp.	Mountain View, Calif.
07387	Birtcher Corp., The	Los Angeles, Calif.
07397	Sylvania Electric Products Inc. Mountain View Operations of Sylvania Electronic Systems	Mountain View, Calif.
07716	International Resistance Co.	Burlington, Iowa
07910	Continental Device Corp.	Hawthorne, Calif.
07933	Raytheon Mfg. Co., Semiconductor Div.	Mountain View, Calif.
08530	Reliance Mica Corp.	Brooklyn, N.Y.
08717	Sloan Company	Sun Valley, Calif.
08730	Vemaline Products Co.	Franklin Lakes, N.J.
08863	Nylomatic Corp.	Morrisville, Pa.
11236	CTS of Berne, Inc.	Berne, Ind.
11237	Chicago Telephone of California, Inc.	So. Pasadena, Calif.
11711	General Instrument Corp., Semiconductor Prod. Group, Rectifier Div.	Newark, N.J.
12136	Philadelphia Handle Co., Inc.	Camden, N.J.
12697	Clarostat Mfg. Co.	Dover, N.H.
14493	Hewlett-Packard Co., Loveland Division	Loveland, Colo.
14655	Cornell-Dubilier Elec. Corp.	Newark, N.J.
14936	General Instrument Corp., Semiconductor Prod. Group, Semiconductor Div.	Hicksville, N.Y.

FROM: F. S. C. M. Handbook Supplements  
H4-1 July, 1967.

CODE NO.	MANUFACTURER	ADDRESS
15909	Daven Div. of Thos. Edison Industries, McGraw Edison Co.	Livingston, N.J.
16299	Corning Glass Works, Electronic Components Div.	Raleigh, N.C.
16758	Delco Radio Div. of General Motors Corp.	Kokomo, Ind.
17545	Atlantic Semiconductors, Inc.	Asbury Park, N.J.
19315	The Bendix Corp., Eclipse Pioneer Div.	Teterboro, N.J.
19701	Electra Mfg. Co.	Independence, Kan.
21520	Fansteel Metallurgical Corp.	No. Chicago, Ill.
22229	Union Carbide Corp., Linde Div., Kemet Dept.	Mountain View, Calif.
22767	ITT Semiconductors, A Division of International Telephone & Telegraph Corp.	Palo Alto, Calif.
24446	General Electric Co.	Schenectady, N.Y.
24455	General Electric Co., Lamp Division	Nela Park, Cleveland, Ohio
24655	General Radio Co.	West Concord, Mass.
28480	Hewlett-Packard Co.	Palo Alto, Calif.
28520	Heyman Mfg. Co.	Kenilworth, N.J.
33173	G. E., Tube Dept.	Owensboro, Ky.
35434	Lectrohm, Inc.	Chicago, Ill.
37942	P.R. Mallory & Co., Inc.	Indianapolis, Ind.
42190	Muter Co.	Chicago, Ill.
44655	Ohmite Manufacturing Co.	Skokie, Ill.
47904	Polaroid Corporation	Cambridge, Mass.
49956	Raytheon Mfg. Co., Microwave and Power Tube Div.	Waltham, Mass.
55026	Simpson Electric Co.	Chicago, Ill.
56289	Sprague Electric Co.	North Adams, Mass.
58474	Superior Electric Co.	Bristol, Conn.
61637	Union Carbide Corp.	New York, N.Y.
63743	Ward-Leonard Electric Co.	Mt. Vernon, N.Y.
70563	Amperite Co., Inc.	Union City, N.J.
70903	Belden Mfg. Co.	Chicago, Ill.
71218	Bud Radio, Inc.	Willoughby, Ohio
71400	Bussmann Mfg. Div. of McGraw-Edison Co.	St. Louis, Mo.
71450	CTS Corporation	Elkhart, Ind.
71468	I. T. T. Cannon Electric Inc.	Los Angeles, Calif.

CODE NO.	MANUFACTURER	ADDRESS
71590	Centralab Div. of Globe Union, Inc.	Milwaukee, Wis.
71700	The Cornish Wire Co.	New York, N.Y.
71744	Chicago Miniature Lamp Works	Chicago, Ill.
71785	Cinch Mfg. Co.	Chicago, Ill.
71984	Dow Corning Corp.	Midland, Mich.
72619	Dialight Corporation	Brooklyn, N.Y.
72699	General Instrument Corp., Capacitor Div.	Newark, N.J.
72765	Drake Mfg. Co.	Chicago, Ill.
72982	Erie Technological Products, Inc.	Erie, Pa.
73138	Helipot Div. of Beckman Instruments, Inc.	Fullerton, Calif.
73293	Hughes Components Division of Hughes Aircraft Co.	Newport Beach, Calif.
73445	Amperex Electronic Co., Div. of North American Phillips Co., Inc.	Hicksville, N.Y.
73506	Bradley Semiconductor Corp.	New Haven, Conn.
73559	Carling Electric, Inc.	Hartford, Conn.
73734	Federal Screw Products, Inc.	Chicago, Ill.
73978	Hardwick Hindle Co., Memcor Components Div.	Huntington, Ind.
74193	Heinemann Electric Co.	Trenton, N.J.
74545	Harvey Hubbel, Inc.	Bridgeport, Conn.
74868	FXR Div. of Amphenol-Borg Electronics Corp.	Danbury, Conn.
75042	International Resistance Co.	Philadelphia, Pa.
75173	Howard B. Jones Div., of Cinch Mfg. Corp. (Use 71785)	New York, N.Y.
75382	Kulka Electric Corp.	Mt. Vernon, N.Y.
75915	Littlefuse, Inc.	Des Plaines, Ill.
76493	J. W. Miller Co.	Los Angeles, Calif.
76854	Oak Manufacturing Co.	Crystal Lake, Ill.
77068	Bendix Corp., Bendix-Pacific Div.	No. Hollywood, Calif.
77221	Phaostron Instrument and Electronic Co.	South Pasadena, Calif.
77252	Philadelphia Steel and Wire Corp.	Philadelphia, Pa.
77342	American Machine and Foundry, Potter and Brumfield Div.	Princeton, Ind.
77630	TRW Electronics, Components Div.	Camden, N.J.

FROM: F. S. C. M. Handbook Supplements  
H4-1 July, 1967.

CODE NO.	MANUFACTURER	ADDRESS
77764	Resistance Products Co.	Harrisburg, Pa.
78189	Shakeproof Div. of Illinois Tool Works	Elgin, Ill.
78488	Stackpole Carbon Co.	St. Marys, Pa.
78526	Stanwyck Winding Co., Inc.	Newburgh, N. Y.
78553	Tinnerman Products, Inc.	Cleveland, Ohio
79307	Whitehead Metal Products Co., Inc.	New York, N. Y.
79727	Continental-Wirt Electronics Corp.	Philadelphia, Pa.
80031	Mepco Div. of Sessions Clock Co.	Morristown, N. J.
80294	Bourns, Inc.	Riverside, Calif.
81042	Howard Industries Inc.	Racine, Wis.
81483	International Rectifier Corp.	El Segundo, Calif.
81751	Columbus Electronics Corp.	Yonkers, N. Y.
82099	Goodyear Sundries & Mechanical Co., Inc.	New York, N. Y.
82219	Sylvania Electric Prod. Inc., Electronic Tube Div.	Emporium, Pa.
82389	Switchcraft, Inc.	Chicago, Ill.
82647	Metals and Controls Inc., Spencer Products	Attleboro, Mass.
82866	Research Products Corp.	Madison, Wis.
82877	Rotron Mfg. Co., Inc.	Woodstock, N. Y.
82893	Vector Electronic Co.	Glendale, Calif.
83058	Carr Fastener Co.	Cambridge, Mass.
83186	Victory Engineering Corp.	Springfield, N. J.
83298	Bendix Corp., Red Bank Div.	Eatontown, N. J.
83330	Herman H. Smith Inc.	Brooklyn, N. Y.
83385	Central Screw Co.	Chicago, Ill.
83501	Gavitt Wire and Cable Co., Div. of Amerace Corp.	Brookfield, Mass.
83594	Burroughs Corp., Electronic Components Div.	Plainfield, N. J.
83877	Yardeny Laboratories, Inc.	New York, N. Y.
84171	Arco Electronics, Inc.	Great Neck, N. Y.
84411	TRW Capacitor Div.	Ogallala, Neb.

CODE NO.	MANUFACTURER	ADDRESS
86684	Radio Corp. of America, Electronic Components & Devices Div.	Harrison, N. J.
87034	Marco Industries Co.	Anaheim, Calif.
87216	Philco Corp. (Lansdale Div.)	Lansdale, Pa.
87585	Stockwell Rubber Co., Inc.	Philadelphia, Pa.
87929	B. M. Tower Co., Inc.	Bridgeport, Conn.
88140	Cutler-Hammer, Inc.	Lincoln, Ill.
89473	General Electric Distributing Corp.	Schenectady, N. Y.
91345	Miller Dial and Nameplate Company	El Monte, Calif.
91637	Dale Electronics, Inc.	Columbus, Neb.
91662	Elco Corp.	Willow Grove, Pa.
91929	Honeywell, Inc., Micro-Switch Div.	Freeport, Ill.
93332	Sylvania Electric Prod., Inc. Semiconductor Prod. Div.	Woburn, Mass.
93410	Stevens Mfg. Co., Inc.	Mansfield, Ohio
94144	Raytheon Co., Components Div., Industrial Components Operation	Quincy, Mass.
94154	Tung-Sol Electric, Inc.	Newark, N. J.
94310	Tru-Ohm Products, Memcor Components Div.	Huntington, Ind.
95263	Leecraft Mfg. Co., Inc.	Long Island City, N. Y.
96791	Amphenol Controls Div. of Amphenol- Borg Electronics Corp.	Janesville, Wis.
98291	Seaelectro Corp.	Mamaroneck, N. Y.
98978	International Electronic Research Corp.	Burbank, Calif.
99934	Renbrandt Inc.	Boston, Mass.
THE FOLLOWING H-P VENDORS HAVE NO NUMBERS ASSIGNED IN THE LATEST SUPPLEMENT TO THE FEDERAL SUPPLY CODE FOR MANUFACTURERS HANDBOOK.		
0000	Cooltron	Oakland, Calif.
00000	Plastic Ware Co.	Brooklyn, N. Y.

FROM: F. S. C. M. Handbook Supplements  
H4-1 July, 1967

Reference Designator	Description	Quantity	Mfr. Part # or Type	Mfr.	Mfr. Code	Stock No.	RS
C1-3,5-9, 12-15,17, 21,22,25	Not Assigned	-	-	-	-	-	-
C4	fxd, paper .047 $\mu$ f 3000vdc	1	187P473930	Sprague	56289	0160-2480	1
C10	fxd, film .082 $\mu$ f 200vdc	1	192P82392	Sprague	56289	0160-0167	1
C11	fxd, film .22 $\mu$ f 80vdc	1	192P2249R8	Sprague	56289	0160-2460	1
C16	fxd, elect 200 $\mu$ f 85vdc	1	D31642	Sprague	56289	0180-1854	1
C18	fxd, elect 10 $\mu$ f 450vdc	1	D38267	Sprague	56289	0180-1944	1
C19	fxd, elect 20 $\mu$ f 200vdc	1	34D206F200FJ4	Sprague	56289	0180-0367	1
C20	fxd, mica 220pf 500v	1	RCM15E221J	Arco	04062	0140-0083	1
C23	fxd, elect 1 $\mu$ f 4000vdc	1	P49991	Sprague	56289	0160-2580	1
C24	fxd, film .0022 $\mu$ f 200vdc	1	192P22292	Sprague	56289	0160-0154	1
C26, 29	fxd, film .1 $\mu$ f 200vdc	2	192P10492	Sprague	56289	0160-0168	1
C27, 28	fxd, paper 1 $\mu$ f 2000vdc	2	264P90	Sprague	56289	0160-2483	1
CR1, 2, 13, 14, 20	Diode	5	1N4828	G. E.	03508	1901-0461	5
CR3-5, 15, 16, 31, 39	Rect. si. 200ma 180prv	7	1N485B	Sylvania	93332	1901-0033	6
CR6	Rect. si. 15v prv	1	1N483B	G. E.	03508	1901-0460	1
CR7, 40	SCR, 150prv 150fbv	2	C6G	G. E.	03508	1884-0038	2
CR8-12, 17-19, 21, 26-28	Not Assigned	-	-	-	-	-	-
CR22-25, 32	Rect. si. 500ma 200prv	6	1N3253	R. C. A.	02735	1901-0389	6
CR29, 30	Rect. si. 400ma 800prv	2	1N3256	R. C. A.	02735	1901-0388	2
CR33-38	Rect. si. 1 amp, 400prv	6	1N5060	G. E.	03508	1901-0328	6
CR41	Voltage doubler si.	1	-	HLAB	09182	1901-0084	1
F1	Fuse cartridge 2A @ 250v 3AG	1	312001	Littlefuse	75915	2110-0001	5
L1	Line inductor	1	-	HLAB	09182	9100-1813	1
L2	Inductor, pair	1	-	HLAB	09182	9100-1814	1
Q1-9	Not Assigned	-	-	-	-	-	-
Q10, 13, 16, 17	SS NPN si.	4	4JX16A1014	G. E.	03508	1854-0371	4
Q11	Med. power NPN si.	1	40422	R. C. A.	02735	1854-0068	1
Q12	SS PNP si.	1	40362	R. C. A.	02735	1853-0041	1
Q14, 15	SS PNP si.	2	2N3702	T. I.	01295	1853-0029	2
R1-17, 22, 27-29, 32-39, 56-58, 62-66	Not Assigned	-	-	-	-	-	-
R18	fxd, comp 15K $\Omega$ $\pm$ 5% 1w	1	-	A. B.	01121	0689-1535	1
R19	fxd, comp 51K $\Omega$ $\pm$ 5% 1w	1	-	A. B.	01121	0689-5135	1
R20, 73	fxd, comp 51K $\Omega$ $\pm$ 5% $\frac{1}{2}$ w	2	-	A. B.	01121	0686-5135	1
R21	fxd, film 31 meg $\Omega$ $\pm$ 10% 2w	1	BB MW 2 watt	Resis. Prod.	77764	-	1
R23, 24	fxd, comp 300 $\Omega$ $\pm$ 5% $\frac{1}{2}$ w	2	-	A. B.	01121	0686-3015	1
R25	fxd, comp 7.5K $\Omega$ $\pm$ 5% $\frac{1}{2}$ w	1	-	A. B.	01121	0686-7525	1
R26	fxd, comp 51 $\Omega$ $\pm$ 5% $\frac{1}{2}$ w	1	-	A. B.	01121	0686-5105	1
R30	fxd, comp 91K $\Omega$ $\pm$ 5% $\frac{1}{2}$ w	1	-	A. B.	01121	0686-9135	1
R31	fxd, comp 430K $\Omega$ $\pm$ 5% $\frac{1}{2}$ w	1	-	A. B.	01121	0686-4345	1
R40	fxd, ww 30K $\Omega$ $\pm$ 5% 10w	1	10XM	W. L.	63743	0811-1918	1
R43	fxd, comp 10K $\Omega$ $\pm$ 5% $\frac{1}{2}$ w	1	-	A. B.	01121	0686-1035	1
R44	fxd, comp 4.7K $\Omega$ $\pm$ 5% $\frac{1}{2}$ w	1	-	A. B.	01121	0686-4725	1
R45	fxd, comp 15K $\Omega$ $\pm$ 5% $\frac{1}{2}$ w	1	-	A. B.	01121	0686-1535	1
R46	fxd, comp 5.1K $\Omega$ $\pm$ 5% $\frac{1}{2}$ w	1	-	A. B.	01121	0686-5125	1

Reference Designator	Description	Quantity	Mfr. Part # or Type	Mfr.	Mfr. Code	Stock No.	RS
R47	fxd, comp 620K $\Omega$ $\pm$ 5% $\frac{1}{2}$ w	1	-	A. B.	01121	0686-6245	1
R48	fxd, comp 3K $\Omega$ $\pm$ 5% $\frac{1}{2}$ w	1	-	A. B.	01121	0686-3025	1
R49	fxd, ww 10K $\Omega$ $\pm$ 1% 5w	1	5SX	W. L.	63743	0811-1866	1
R50	fxd, film 221K $\Omega$ $\pm$ 1% 1/8w	1	-	I. R. C.	07716	0757-0473	1
R51	fxd, film selective $\pm$ 1% $\frac{1}{4}$ w	1	-	I. R. C.	07716	-	-
R52	fxd, comp selective $\pm$ 5% $\frac{1}{2}$ w	1	-	A. B.	01121	-	-
R53, 60	fxd, comp 510 $\Omega$ $\pm$ 5% $\frac{1}{2}$ w	2	-	A. B.	01121	0686-5115	1
R54	fxd, comp 100K $\Omega$ $\pm$ 5% 1w	1	-	A. B.	01121	0689-1045	1
R55	fxd, comp 33K $\Omega$ $\pm$ 5% $\frac{1}{2}$ w	1	-	A. B.	01121	0686-3335	1
R59	fxd, comp 12K $\Omega$ $\pm$ 5% $\frac{1}{2}$ w	1	-	A. B.	01121	0686-1235	1
R61, 74	fxd, comp 200 $\Omega$ $\pm$ 5% $\frac{1}{2}$ w	2	-	A. B.	01121	0686-2015	1
R67	var, ww 100K $\Omega$ Series 70	1	HQ 3427	C. T. S.	11236	2100-0095	1
R68	fxd, comp 390 $\Omega$ $\pm$ 5% $\frac{1}{2}$ w	1	-	A. B.	01121	0686-3915	1
R69, 79	fxd, ww 50 $\Omega$ $\pm$ 1% 5w	2	5XM	W. L.	63743	0811-1854	1
R70	var, ww 250 $\Omega$ , Type 110	1	-	C. T. S.	11236	2100-0439	1
R71	var, ww 25K $\Omega$ Series 70	1	JL-9176	C. T. S.	11236	2100-1534	1
R72	fxd, comp 33K $\Omega$ $\pm$ 5% $\frac{1}{2}$ w	1	-	A. B.	01121	0686-3335	1
R75, 80	fxd, comp 1K $\Omega$ $\pm$ 5% $\frac{1}{2}$ w	2	-	A. B.	01121	0686-1025	1
R76	fxd, comp 20K $\Omega$ $\pm$ 5% $\frac{1}{2}$ w	1	-	A. B.	01121	0686-2035	1
R77, 78	fxd, comp 200K $\Omega$ $\pm$ 5% $\frac{1}{2}$ w	2	-	A. B.	01121	0686-2045	1
S1	Switch, pilot light (red) comb.	1	54-61681 - 26 A1H	Marco	87034	3101-0100	1
S2	Thumbwheel Switch (See parts listed below marked with an *)	1	-	HLAB	09182	06516-60001	1
*R200	Special Type 43, 10K $\Omega$ $\pm$ 5%	1	100336-2	Clarostat	12697	2100-2044	1
*R201-206	fxd, film 10K $\Omega$ $\pm$ 1% $\frac{1}{2}$ w	6	-	I. R. C.	07716	0757-0839	2
*R207-209	fxd, ww 10K $\Omega$ $\pm$ 1% 5w	3	5SX	W. L.	63743	0811-1866	1
*R211-216	fxd, film 100K $\Omega$ $\pm$ 1% $\frac{1}{2}$ w	6	-	I. R. C.	07716	0757-0367	2
*R217-219	fxd, ww 100K $\Omega$ $\pm$ 1% 1w	3	421E1003FC3	Sprague	56289	-	1
*R221-224	fxd, ww 500K $\Omega$ $\pm$ 1%	4	421E5003FC3	Sprague	56289	-	1
*S201-203	Rotary switch, 10 position, S. P. KEL-F	2	253225-FV	Oak	81716	3100-1902	1
*S204	Rotary switch, 4 position, S. P. KEL-F	1	244909-FV	Oak	81716	3100-1901	1
	*P. C. Board Ass'y, Pot.	1	-	HLAB	09182	06516-60002	1
	*P. C. Board Ass'y, high voltage	1	-	HLAB	09182	06516-60003	1
	*P. C. Board - Thumbwheel	2	-	HLAB	09182	5020-5508	1
	*Thumbwheel Stamping	3	-	HLAB	09182	4040-0047	1
	*Thumbwheel Stamping	1	-	HLAB	09182	4040-0048	1
	*Gear and Shaft	3	-	HLAB	09182	4040-0049	1
	*Stop Pin	1	R62-2	Bead Chain	70892	-	1
	*Square Nut, 4-40, $\frac{1}{4}$ x 3/32	2	70002	Fed. Screw	73734	-	2
T1	H. V. Power Transformer	1	-	HLAB	09182	9100-1811	1
T2	Bias Transformer	1	-	HLAB	09182	9100-1812	1
VR1	Diode, zener 9.4v T. C.	1	1N2163A	Motorola	04713	1902-0763	1
VR2	Diode, zener 20.5v	1	1N968	Motorola	04713	1902-0182	1
VR3	Neon	1	NE76	G. E.	03508	2140-0019	1
VR4	Diode, zener 42.2v	1	1N976	Motorola	04713	1902-3323	1
	Meter, 2 $\frac{1}{4}$ " size, scale 0-3.5kv	1	-	HLAB	09182	1120-1127	1
	Meter Spring	4	-	HLAB	09182	1460-0256	1
	Meter Bezel, 1/6 Mod.	1	-	HLAB	09182	5040-0651	1
	BNC-HV Blukhead Jack Recp.	2	30376-1	HLAB	09182	1250-0735	1
	Plug Assembly	2	651530	HLAB	09182	-	1
	Delrin Spacer	6	100327	HLAB	09182	-	2
	Capacitor Clamp	2	36-928	Sprague	56289	-	1



Reference Designator	Description	Quantity	Mfr. Part # or Type	Mfr. Code	Mfr. Stock No.	RS	
	Fuse Holder	1	342014	Littlefuse	75915	1400-0048	1
	Rubber Bumper	1	4072	Stockwell	87575	-	1
	Rubber Bumper	4	MB50-701	Stockwell	87575	-	1
	Fastener	8	C8091-632-4	Tinnerman	89032	-	2
	Fastener	2	C8022-632-4	Tinnerman	89032	-	1
	Fastener	4	C8082-832-1	Tinnerman	89032	-	1
	Line Cord, plug PH151 7½ ft.	1	HK-4701	Beldon	70903	-	1
	Strain Relief Bushing	1	SR-5P-1	Heyco	28520	-	1
	Plug Cable	2	S. M. L.	HLAB	09182	5080-7109	1
OPTION 05							
L3	Inductor	1		HLAB	09128	9100-2148	1
T1	Power Transformer	1		HLAB	09182	9100-1811	1
T2	Bias Transformer	1		HLAB	09182	9100-1812	1
OPTION 18							
L3	Inductor	1		HLAB	09182	9100-2149	1
T1	Power Transformer	1		HLAB	09182	9100-2138	1
T2	Bias Transformer	1		HLAB	09182	9100-2139	1
OPTIONS 05 AND 18							
L3	Inductor	1		HLAB	09182	9100-2140	1
T1	Power Transformer	1		HLAB	09182	9100-2138	1
T2	Bias Transformer	1		HLAB	09182	9100-2139	1

APPENDIX I  
MANUAL BACKDATING CHANGES

Manual backdating changes describe changes necessary to adapt this manual to earlier instruments. To adapt the manual to serial numbers prior to 6F0161, make the following changes:

CHANGE 1: On the schematic, remove CR30 and center tap connection at terminal 13 in the secondary of T2 and add new resistor and zener diodes as shown on the sketch below.

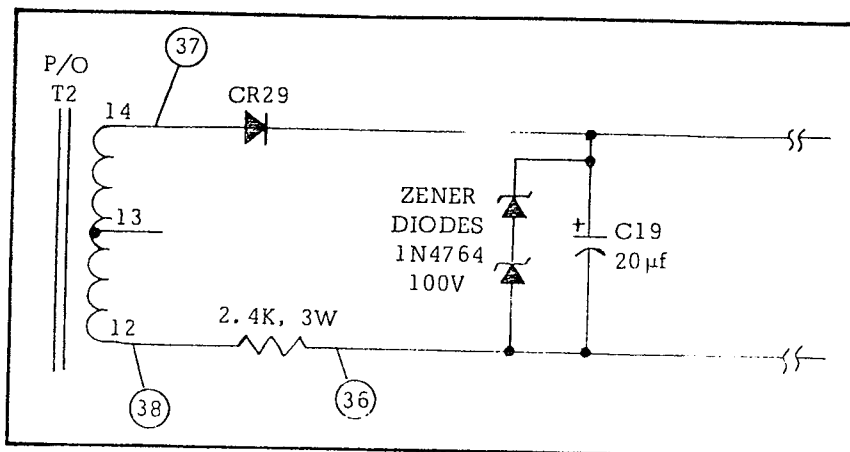

# HIGH VOLTAGE CONTROL CIRCUIT WAVEFORMS

## NORMAL WAVEFORMS

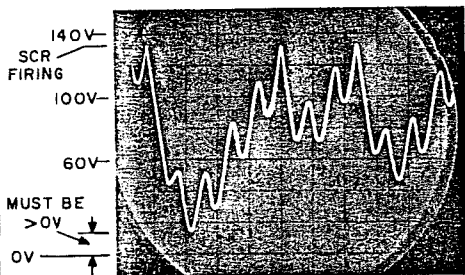

TP(11) TO (+)  
20V/CM  
10MS/CM

115VAC INPUT  
3000V/6MA OUTPUT

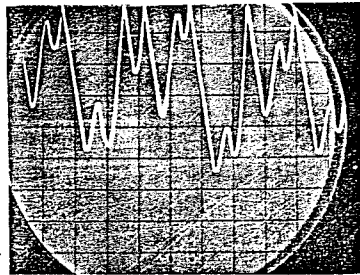

TP(11) TO (+)  
20V/CM  
10MS/CM

115VAC INPUT  
1500V/6MA OUTPUT

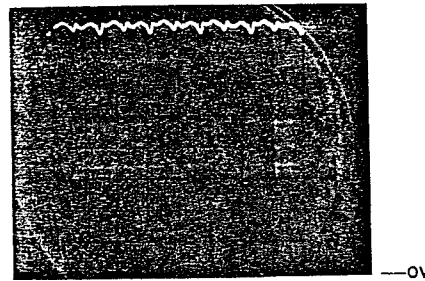

TP(11) TO (+)  
20V/CM  
10MS/CM

115VAC INPUT  
0V/0MA OUTPUT

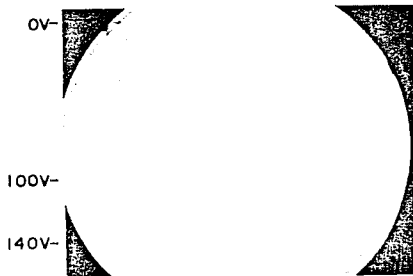

TP(36) TO (+)  
20V/CM  
10MS/CM

115VAC INPUT  
3000V/6MA OUTPUT

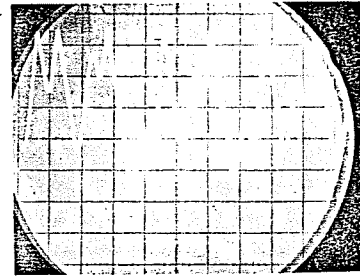

TP(36) TO (+)  
20V/CM  
10MS/CM

115VAC INPUT  
1500V/6MA OUTPUT

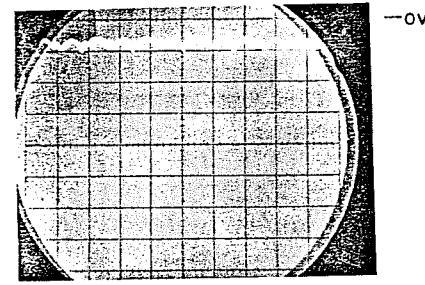

TP(36) TO (+)  
20V/CM  
10MS/CM

115VAC INPUT  
0V/0MA OUTPUT

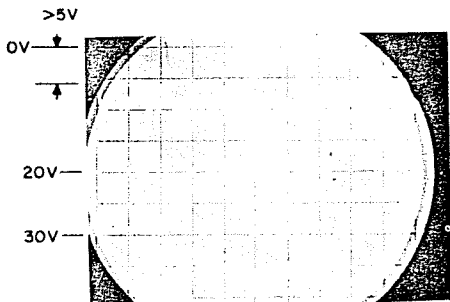

TP(36) TO (+)  
5V/CM  
10MS/CM

105VAC INPUT  
0V/0MA OUTPUT

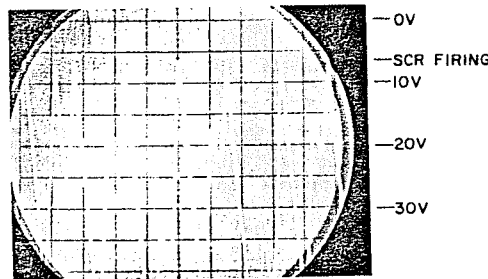

TP(36) TO (+)  
5V/CM  
10MS/CM

105VAC INPUT  
500V/2MA OUTPUT

## TYPICAL TROUBLES

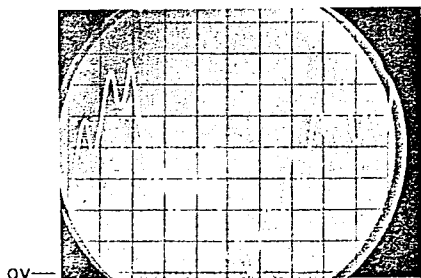

TP(11) TO (+)  
20V/CM  
10MS/CM

115VAC INPUT  
3000V/6MA OUTPUT

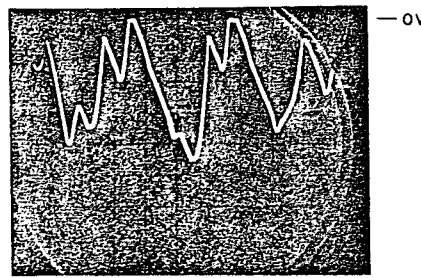

TP(36) TO (+)  
20V/CM  
10MS/CM

115VAC INPUT  
3000V/6MA OUTPUT

WAVEFORM INDICATES MISADJUSTMENT OF PROTECTION CIRCUIT. NOTE THAT NEGATIVE PEAK IS TOUCHING 0V BASE LINE

WAVEFORM INDICATES ONE SCR (CR7 OR CR40) NOT FIRING. NOTE POSITIVE PEAKS TOUCH 0V BASE LINE

NOTE: ALL WAVEFORMS ARE DC COUPLED

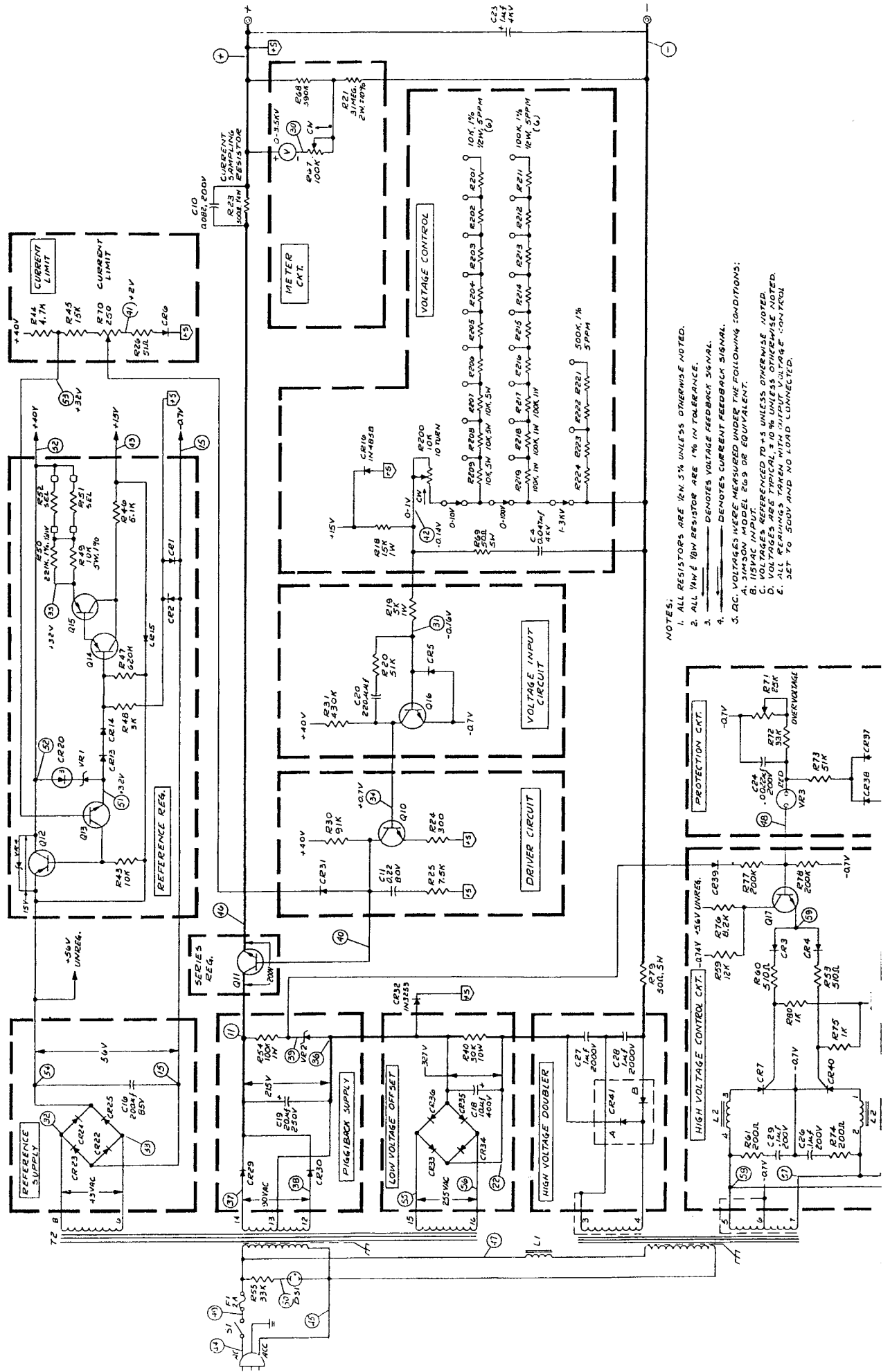

- NOTES:
1. ALL RESISTORS ARE 1/4W 5% UNLESS OTHERWISE NOTED.
  2. ALL 1/4W 1/8W RESISTOR ARE 1% IN TOLERANCE.
  3. ———— DENOTES VOLTAGE FEEDBACK SIGNAL.
  4. ———— DENOTES CURRENT FEEDBACK SIGNAL.
  5. AC VOLTAGES WERE MEASURED UNDER THE FOLLOWING CONDITIONS:
    - A. SIMONSON MODEL 269 OR EQUIVALENT.
    - B. VOLTAGES REFERENCED TO +5 UNLESS OTHERWISE NOTED.
    - C. VOLTAGES ARE TYPICAL ±10% UNLESS OTHERWISE NOTED.
    - D. ALL READINGS TAKEN WITH INPUT VOLTAGE CONTROL SET TO 500V AND NO LOAD CONNECTED.